

IT Leggere il manuale d'uso. Conservare con cura le istruzioni per ogni futura consultazione.

EN Please retain these instructions in a safe place for further reference.

NL Lees de bedieningshandleiding. Bewaar deze instructies zorgvuldig voor toekomstig gebruik.

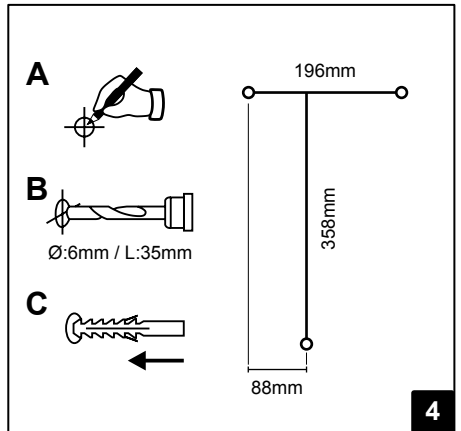

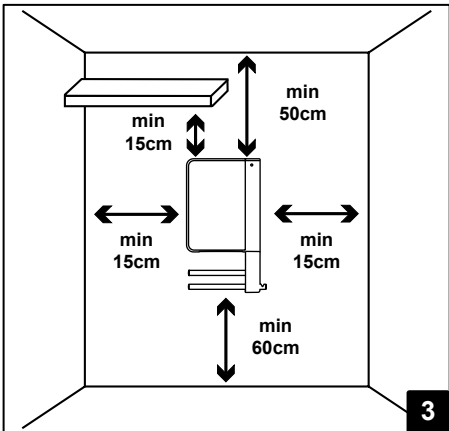
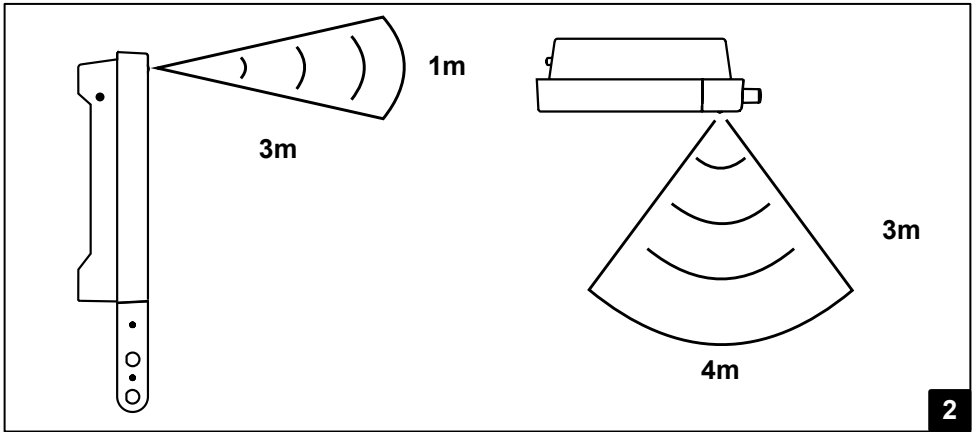
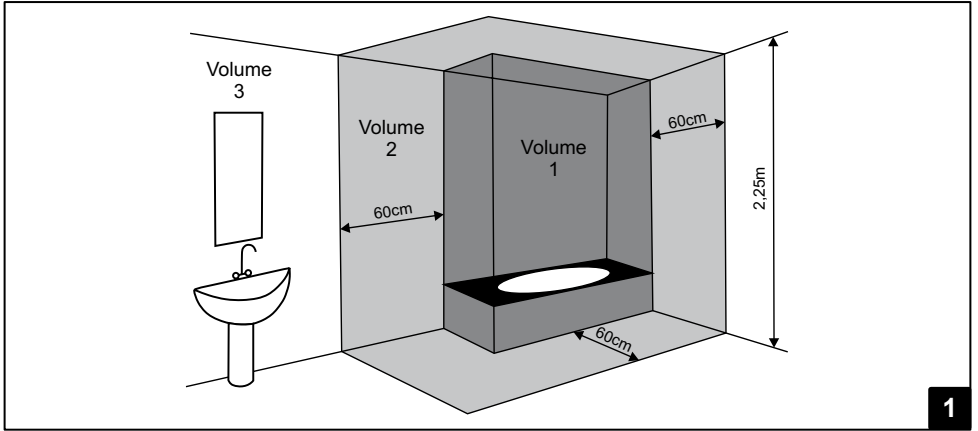
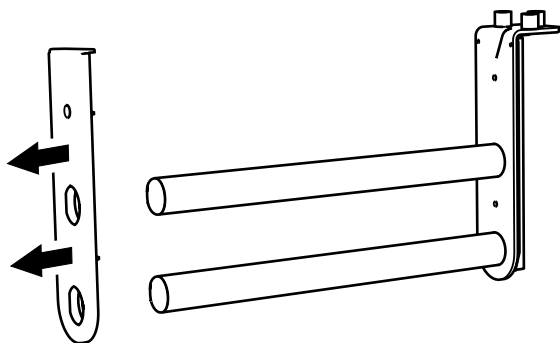
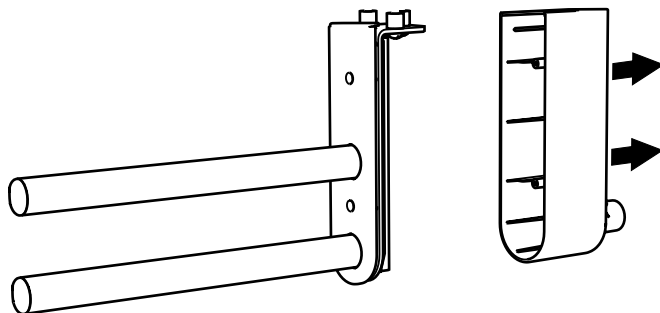
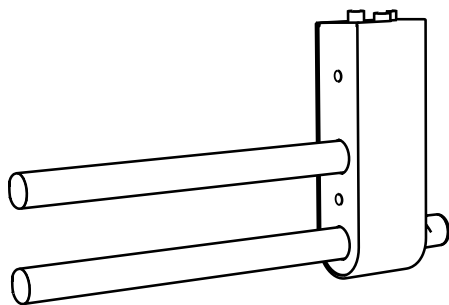

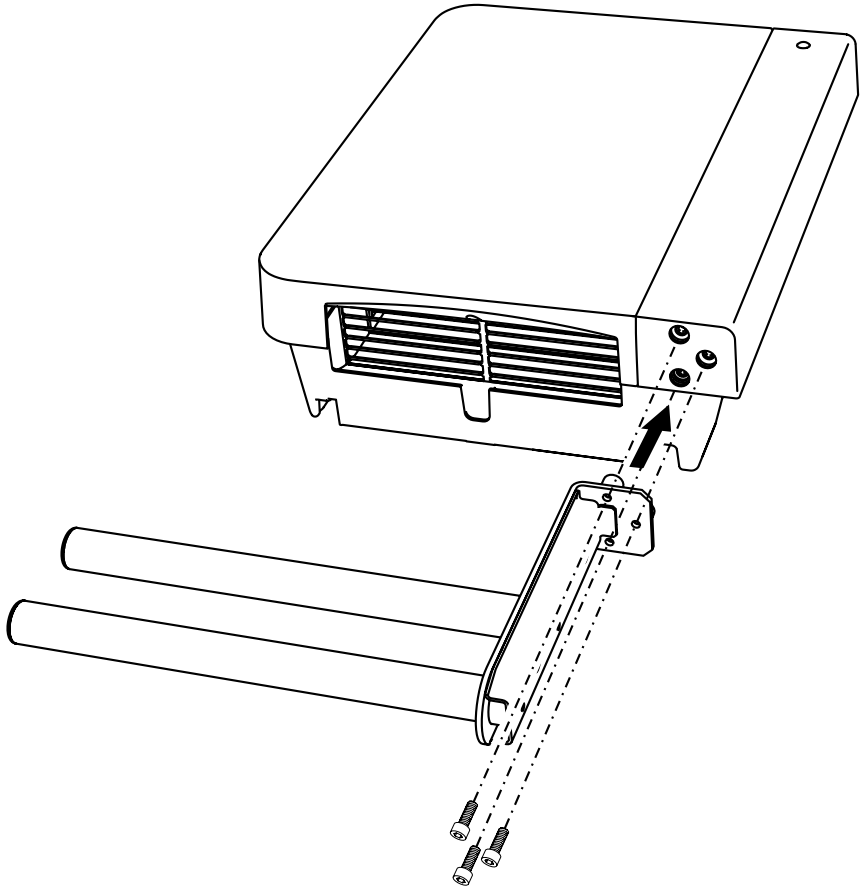

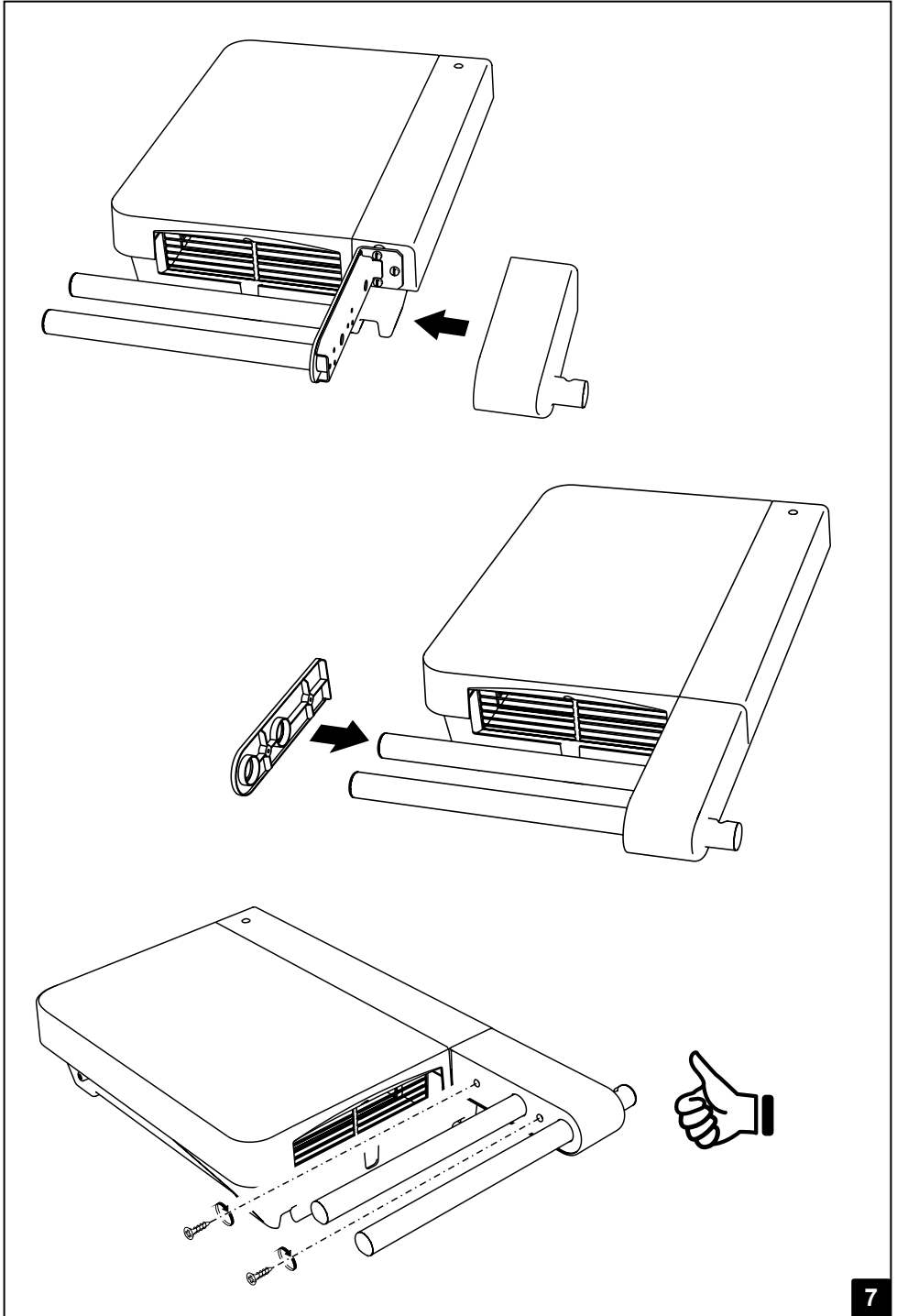

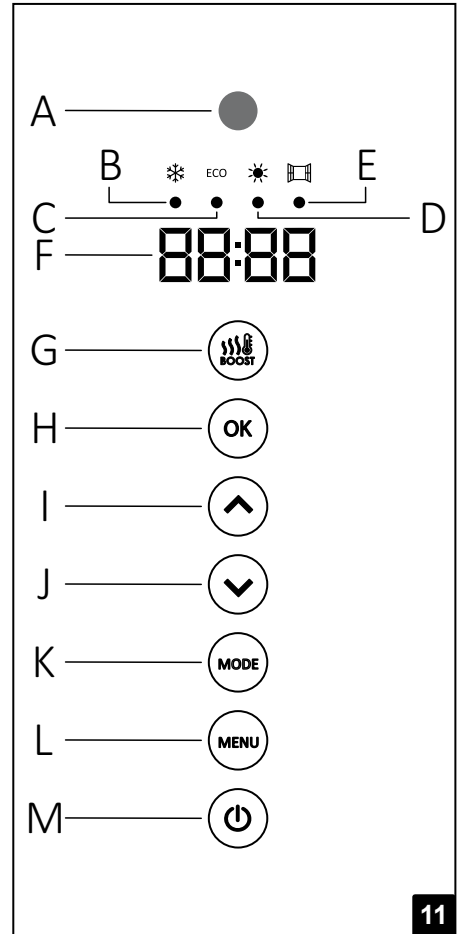
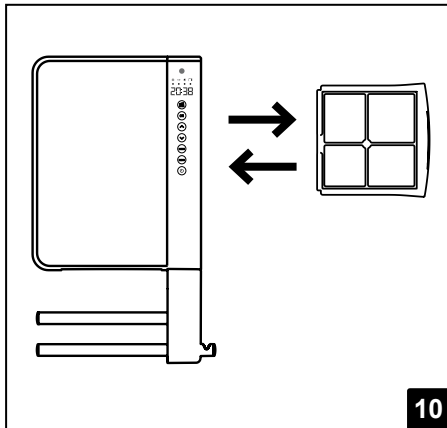
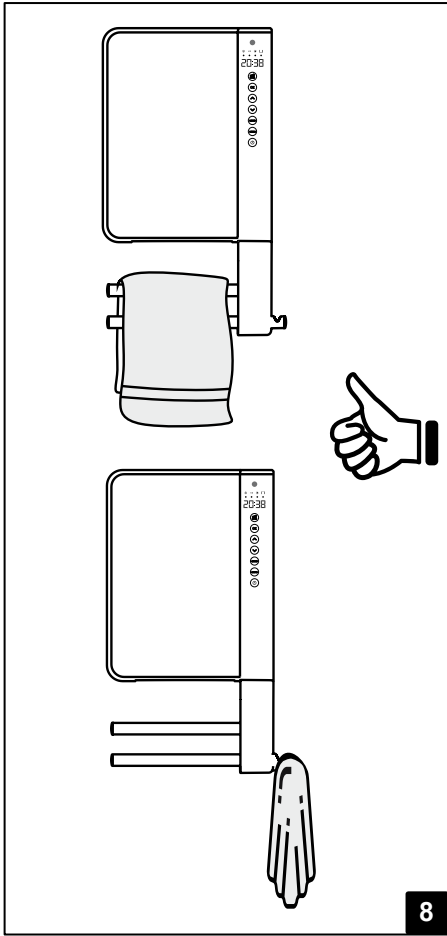

Si prega di leggere attentamente queste istruzioni, prima di utilizzare il prodotto, in modo da evitare danneggiamenti o comunque il verificarsi di situazioni di pericolo. Qualsiasi utilizzo del prodotto diverso da quanto indicato nel presente manuale può causare incendi, pericoli elettrici o ferite e rende nulla qualsiasi garanzia.

La garanzia non si applica ad alcun difetto, deterioramento, perdita, ferimento o danneggiamento riconducibili ad un uso non corretto del prodotto. Rimangono garantiti tutti i diritti di legge in materia. Nessuna condizione di garanzia può escludere o modificare le condizioni di garanzia regolamentate da leggi dello Stato che non possono essere a nessun titolo escluse o modificate.

Prima di ogni operazione, rimuovere con cura l'imballo e controllare la perfetta integrità del prodotto. Nel caso si evidenziasse dei difetti o danni, non installare né cercare di riparare l'apparecchiatura, ma rivolgersi al rivenditore. Non lasciare l'imballo alla portata dei bambini e smaltire le parti in conformità con le disposizioni vigenti.

1. PER LA VOSTRA SICUREZZA

- Questo prodotto è per uso domestico e non è adatto per l'utilizzo in ambienti commerciali/industriali o su veicoli, imbarcazioni o aeromobili.
- L'apparecchio può essere utilizzato da bambini di età non inferiore a 8 anni e da persone con ridotte capacità fisiche, sensoriali o mentali, o prive di esperienza o della necessaria conoscenza, purché sotto sorveglianza oppure dopo che le stesse abbiano ricevuto istruzioni relative all'uso sicuro dell'apparecchio e alla comprensione dei pericoli ad esso inerenti. I bambini non devono giocare con l'apparecchio. La pulizia e la manutenzione destinata ad essere effettuata dall'utilizzatore non deve essere effettuata da bambini senza sorveglianza.
- I bambini di età inferiore a 3 anni non devono avvicinarsi al prodotto se non costantemente supervisionati.
- I bambini di età compresa fra 3 e 8 anni possono solamente accendere e spegnere l'apparecchio purché esso sia stato installato e posizionato secondo le normali condizioni d'uso e loro siano supervisionati o adeguatamente istruiti riguardo al corretto e sicuro utilizzo del prodotto e ne abbiano compresa la pericolosità. I bambini di età compresa fra 3 e 8 anni non possono collegare il prodotto, regolarlo, pulirlo o effettuare manutenzione.
- **ATTENZIONE: Alcune parti di questo prodotto possono diventare molto calde e causare bruciate. Particolare attenzione deve essere prestata in presenza di bambini o persone vulnerabili.**
- Assicuratevi che l'alimentazione di rete corrisponda ai dati di tar-

ga: 230V~, 50Hz.

- Questo termoventilatore ha un grado di protezione IPX4 e può quindi essere utilizzato nei bagni PURCHE' NON SIA INSTALLATO ENTRO IL PERIMETRO DELLA VASCA O DELLA DOCCIA. Il prodotto non può quindi essere installato nelle aree indicate come Volume 1 nello schema di figura 1.
- Durante il funzionamento collocate il termoventilatore in una posizione sicura ovvero:
 - ad almeno 1m da oggetti infiammabili o mobili;
 - lasciando libera la griglia di uscita dell'aria: nessun oggetto deve essere presente nel raggio di 1m dalla griglia di uscita;
 - mai posizionato immediatamente sotto ad una presa di corrente.
- Non lasciate che animali o bambini giochino o tocchino il termoventilatore. Attenzione! Durante il funzionamento la griglia di uscita dell'aria può diventare molto calda (oltre 90°C);
- **IMPORTANTE: per evitare surriscaldamenti non ricoprite mai il prodotto.** Non appoggiate mai alcun oggetto o coperta sull'apparecchio mentre è in funzione. Questo è chiaramente scritto sull'apparecchio o illustrato dal simbolo



- Non utilizzate il termoventilatore in stanze sature di gas esplosivi, di vapori generati da solventi e vernici o comunque di vapori/gas infiammabili.
- Se il cavo è danneggiato e dovete sostituirlo non eseguite questa operazione da soli, riportate il termoventilatore ad un centro di riparazioni autorizzato perché è richiesto l'intervento di personale specializzato al fine di evitare qualunque rischio di danneggiamento.
- Il termoventilatore deve essere posizionato in modo tale che la presa di alimentazione sia sempre raggiungibile.
- Non installate il prodotto su pareti di materiale sintetico.

2. MONTAGGIO A MURO

- Installare il termoventilatore in posizione verticale con la griglia di uscita dell'aria rivolta verso il basso.
- Questo termoventilatore è in doppio isolamento elettrico (classe II) pertanto la connessione di terra non è richiesta.
- Questo termoventilatore deve essere installato seguendo le norme in vigore nel paese di installazione.
- In ambienti umidi come bagni e cucine la connessione alla rete elettrica deve essere ad almeno 25 cm di altezza dal suolo. I dispositivi di disconnessione dalla rete di alimentazione devono consentire la disconnessione completa nelle condizioni della categoria di sovratensioni III.
- Per decidere l'installazione ideale, si tenga presente che il sensore rileva i movimenti entro l'area descritta dalla figura 2. Installate il termoventilatore nella migliore posizione che consente di rilevare le persone all'interno della stanza e avere campo libero da oggetti che possono interferire con il raggio del sensore stesso. Il rilevamento è più efficace quando le persone si muovono davanti al prodotto invece che verso di esso.
- L'apparecchio deve essere installato a muro, rispettando le distanze minime dal soffitto, dal pavimento e dalle pareti laterali indicate in figura 3. Mai installare il prodotto ad una distanza dal pavimento inferiore a 600mm:
 - Praticate nel muro 3 fori di diametro 6mm rispettando le distanze indicate in figura 4;
 - Inserite i tre tasselli forniti con il prodotto;
 - Inserite le 2 viti in alto, fornite nello stesso sacchetto, avendo cura di lasciare 8mm tra la testa della vite ed il muro;
 - Fate agganciare il prodotto alle 2 viti che avete fissato tenendolo sempre saldamente tra le mani; **ATTENZIONE!** Prima di lasciare il prodotto verificate che sia bene agganciato alle 2 viti;
 - Fissate infine il prodotto con la terza vite in basso.

3. BARRA PORTA SALVIETTE (PER VERSIONI CHE LA PREVEDONO)

- Prima di installare il termoventilatore a parete è necessario fissare la barra porta salviette che viene fornita separata dal prodotto. A tale scopo:
 - Rimuovete le 2 coperture in plastica come indicato in figura 5;
 - Fissate la barra al termoventilatore con le 3 viti in dotazione come indicato in figura 6;
 - Riposizionate le coperture in plastica come indicato in figura 7;
 - Fissate le coperture in plastica usando le 2 viti in dotazione come indicato in figura 7.
- Le salviette devono essere posizionate correttamente sul supporto, come indicato in figura 8 e NON come indicato in figura 9, per evitare surriscaldamenti e malfunzionamenti.

4. FILTRO

- Il vostro prodotto è dotato di un filtro per proteggere gli elementi riscaldanti dalla polvere e dallo sporco.
- Il filtro è facilmente rimuovibile e può essere lavato con acqua (figura 10).
- Per un corretto funzionamento del prodotto consigliamo di pulire il filtro almeno una volta ogni 6 mesi **RICORDANDOSI DI INSERIRLO NUOVAMENTE NELLA SUA SEDE DOPO IL LAVAGGIO.**
- Ogni 120 ore di funzionamento l'utente viene avvisato della necessità di pulire il filtro posto sul retro del prodotto. L'avviso avviene tramite la visualizzazione a display della scritta scorrevole
"CLEAN FILTER - PULIRE FILTRO".
- Anche se il display visualizza la scritta sopra indicata il prodotto continua a funzionare nella modalità attiva al momento della comparsa dell'avviso.
- La pressione di un qualsiasi tasto cancella l'avviso e azzerà il contatore interno.

5. DESCRIZIONE DEI COMANDI E DEL FUNZIONAMENTO

- Il termoventilatore è dotato di un pulsante di accensione e spegnimento posto sul fianco sinistro. Spegnendo il prodotto i componenti elettrici interni non saranno più sotto tensione.
- I seguenti controlli sono integrati sul frontale del prodotto (figura 11):
 - A - Sensore di presenza
 - B - Indicatore led modalità Antigelo
 - C - Indicatore led modalità Eco
 - D - Indicatore led modalità Comfort
 - E - Indicatore led funzione rilevamento finestra aperta
 - F - Display
 - G - Funzione Boost
 - H - Ok/conferma
 - I - Mostra e aumenta
 - J - Mostra e diminuisce
 - K - Mode
 - L - Menu
 - M - Stand-by

Questo termoventilatore incorpora un sensore di presenza e un sistema di gestione automatica della potenza.

Il sensore di presenza permette una riduzione del consumo energetico abbassando automaticamente la temperatura ambiente quando il locale non è occupato per almeno 10 minuti. Il ritorno alla temperatura di Comfort avviene automaticamente non appena viene nuovamente rilevata una presenza.

Il selettore automatico di potenza invece permette una gestione ottimale dei consumi ed una regolazione precisa del livello di comfort mantenendo automaticamente la temperatura selezionata costante nel tempo, in accordo con quanto è stato impostato sul termostato elettronico.

Il prodotto può essere utilizzato scegliendo fra 4 distinte modalità:

- ANTIGELO
- PROGRAMMATA
- AUTOMATICA
- BASE

Modalità Antigelo

Il termostato viene impostato per mantenere $7\pm 3^{\circ}\text{C}$. La funzione si attiva manualmente oppure automaticamente quando non viene rilevata alcuna presenza nel locale per almeno 36 ore. In questo caso, non appena verrà nuovamente rilevata una presenza, il prodotto imposterà automaticamente la modalità automatica.

Modalità Programmata

Il prodotto può essere programmato selezionando, per ogni giorno della settimana, quale dei 5 profili preimpostati, si desidera utilizzare. Per tutto il tempo di funzionamento in modalità programmata il sensore di presenza viene disattivato affinché il prodotto possa correttamente seguire il profilo di temperature impostato dall'utente.

In modalità Programmata è inoltre disponibile una speciale funzione, attivabile a scelta dell'utente, che permette di rilevare l'eventuale apertura di una finestra e forzare il funzionamento in modalità Antigelo per limitare al massimo lo spreco di energia.

Modalità Automatica

Il prodotto è impostato per funzionare ad una temperatura Comfort ogni qualvolta qualcuno venga rilevato nella stanza. In caso di mancato rilevamento di qualsiasi presenza per più di 10 minuti, il termoventilatore imposta automaticamente la temperatura Eco ($3,5^{\circ}\text{C}$ meno della temperatura Comfort impostata). Se il mancato rilevamento di presenza dovesse protrarsi per più di 36 ore, il termoventilatore imposta automaticamente la funzione Antigelo (7°C). In caso il prodotto dovesse rilevare una presenza per un tempo di almeno 2 minuti, il termoventilatore riporta automaticamente la temperatura al livello di comfort impostato.

In modalità Automatica è inoltre disponibile una speciale funzione, attivabile a scelta dell'utente, che permette di rilevare l'eventuale apertura di una finestra e forzare il funzionamento in modalità Antigelo per limitare al massimo lo spreco di energia.

Modalità Base

Il prodotto funziona in modalità Comfort e il rilevamento di presenza è **disattivato** e non influisce sulla temperatura impostata come avviene nella modalità automatica.

In modalità BASE è inoltre disponibile una speciale funzione, attivabile a scelta dell'utente, che permette di rilevare l'eventuale apertura di una finestra e forzare il funzionamento in modalità Antigelo per limitare al massimo lo spreco di energia.

6. UTILIZZO DEL TERMOVENTILATORE

PULSANTE DI ACCENSIONE/SPEGNIMENTO
(situato sul lato sinistro del prodotto)



L'alimentazione del prodotto è controllata tramite un pulsante elettromeccanico di accensione e spegnimento. Spegnerne il prodotto tramite questo pulsante causa l'interruzione di alimentazione della scheda elettronica provocando, dopo 30 minuti di interruzione, la perdita delle impostazioni immesse. Raccomandiamo di utilizzare questo pulsante in caso non si debba usare il prodotto per un periodo prolungato di tempo e di utilizzare invece il controllo frontale di Accensione / Stand-by, in caso di breve interruzione di utilizzo del prodotto, in modo da non perdere le impostazioni di regolazione precedentemente immesse.

Al primo utilizzo del prodotto, o in caso di mancata alimentazione per un periodo superiore a 30 minuti, quando viene acceso il termoventilatore sul display compare l'indicazione 00:00 e l'orologio inizia a contare il tempo.



In caso non venga immessa nessuna impostazione entro 15 minuti dall'accensione, il prodotto imposta automaticamente la funzione Antigelo, accendendo il led corrispondente.

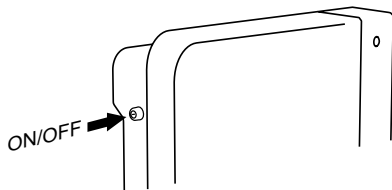

PULSANTE STAND-BY



Usare il pulsante  per accendere o mettere in Stand-by il prodotto. All'accensione il led corrispondente alla temperatura di funzionamento attiva si accende.



ECO



Esempio di attivazione in Comfort.

PULSANTE MENU



Il pulsante  permette di accedere alle varie impostazioni del prodotto ovvero alla regolazione dell'ora, del giorno, del programma settimanale di funzionamento e della funzione di rilevamento dell'apertura di una finestra.

Impostazione dell'orario



Hour

Attivare la visualizzazione/modifica dell'orario

premendo il tasto  fino a visualizzare la scritta "Hour".
Dopo 3 secondi:

00:00

Le 2 cifre dell'ora lampeggiano

Selezionare l'ora corrente



usando i tasti  e 

Premere il tasto OK per confermare



21:00

Le 2 cifre dei minuti lampeggiano

Selezionare i minuti correnti usando i tasti  e 

Premere il tasto OK per confermare



Impostazione del giorno della settimana





DAY

Attivare la visualizzazione/modifica del giorno della settimana premendo il tasto  fino a visualizzare la scritta "DAY". Dopo 3 secondi:

Mo

Le 2 cifre del giorno lampeggiano

Selezionare il giorno corrente usando i tasti  e 

Premere il tasto OK per confermare



Impostazione del programma settimanale

La funzione di programmazione permette di scegliere, per ogni giorno della settimana, quale dei seguenti tre programmi preimpostati di funzionamento utilizzare:

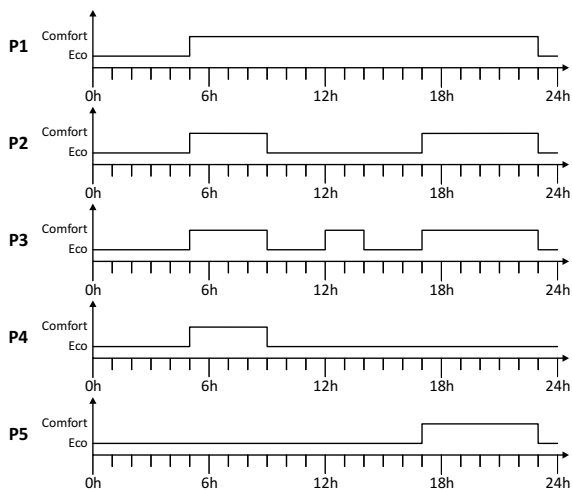



Prog

Attivare la visualizzazione/modifica della programmazione premendo il tasto  fino a visualizzare la scritta "Prog". Dopo 3 secondi:

Mo: P1

Le 2 cifre del primo giorno lampeggiano



Selezionare il giorno desiderato usando i tasti  e 

Premere il tasto OK per confermare



Mo: P1

Le 2 cifre del programma lampeggiano



Selezionare il programma desiderato usando i tasti  e 

Premere il tasto OK per confermare



Mo:P1

Le 2 cifre del giorno appena impostato tornano a lampeggiare affinché si possa procedere con la selezione di un altro giorno



Selezionare il giorno desiderato usando i tasti  e 

Premere il tasto OK per confermare



Tu:P2

Le 2 cifre del programma lampeggiano

Selezionare il programma desiderato usando i tasti  e 

Premere il tasto OK per confermare



Procedere così per tutti i giorni che si desidera visualizzare e/o modificare.

End

Al termine della procedura, dopo la visualizzazione dell'ultimo giorno (domenica), un'ulteriore pressione del tasto  permette di terminare la programmazione. Sul display viene visualizzata la scritta "End".

Premere il tasto OK per uscire dalla programmazione.



In ogni momento è possibile uscire dalla programmazione salvando le modifiche effettuate premendo il tasto .

Impostazione del rilevamento finestra aperta

Questa funzione permette di identificare l'apertura di una finestra e di impostare automaticamente il modo di funzionamento Antigelo. L'accensione contemporanea dei led sotto il simbolo antigelo e sotto il simbolo della finestra indica che è stata rilevata l'apertura di una finestra ed è stato automaticamente impostata la modalità Antigelo.



Il ripristino del normale funzionamento non è automatico ma si ottiene premendo uno qualsiasi dei tasti del prodotto.



Il corretto funzionamento di questa funzione può dipendere dal posizionamento del prodotto del locale, dalla presenza di spifferi, dalla temperatura esterna e dal tempo di apertura della finestra.



OPEN

Attivare la visualizzazione/modifica dello stato di attivazione della funzione di rilevamento della finestra aperta premendo il tasto  fino a visualizzare la scritta scorrevole "OPEN Window"

OPEN



Le scritta scorre sul display

Premere il tasto OK per visualizzare lo stato della funzione



YES

Le scritta "YES" indica che la funzione è attiva



Attivare o disattivare la funzione usando i tasti  e 

Premere il tasto OK per confermare



NO

Le scritta "NO" indica che la funzione è disattiva

Attivare o disattivare la funzione usando i tasti  e 

Premere il tasto OK per confermare



La pressione del pulsante  permette di selezionare uno delle 4 modalità di funzionamento descritte nel paragrafo 5.



FROS

Modalità ANTIGELO

Il termostato viene automaticamente impostato alla temperatura di $7\pm 3^{\circ}\text{C}$.

Il led corrispondente alla temperatura Antigelo si accende.

In questa modalità la funzione di rilevamento finestra aperta è disabilitata.

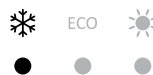

Prog

Modalità PROGRAMMATA

Il termostato funziona per raggiungere e mantenere la temperatura impostata nel programma settimanale (vedere pulsante MENU).

Il led corrispondente alla temperatura di Comfort o di Eco si accende in funzione delle impostazioni previste per l'ora e il giorno correnti.

In questa modalità la funzione di rilevamento finestra aperta può essere abilitata o disabilitata utilizzando il pulsante MENU (impostazione "OPEN Window").

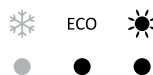

Auto

Modalità AUTOMATICA

Il termostato funziona per raggiungere e mantenere la temperatura di Comfort e passa automaticamente prima alla temperatura di Eco e poi a quella Antigelo se non viene rilevata alcuna presenza nell'ambiente.

Il led corrispondente alla temperatura di Comfort, Eco o Antigelo si accende in base alle informazioni ricevute dal sensore di presenza.

In questa modalità la funzione di rilevamento finestra aperta può essere abilitata o disabilitata utilizzando il pulsante MENU (impostazione "OPEN Window").

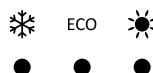

BASE

Modalità BASE

Il termostato funziona per raggiungere e mantenere la temperatura di Comfort disattivando il sensore di presenza.

Il led corrispondente alla temperatura di Comfort si accende.

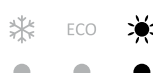

In questa modalità la funzione di rilevamento finestra aperta può essere abilitata o disabilitata utilizzando il pulsante MENU (impostazione "OPEN Window").



PULSANTI DI SELEZIONE



I pulsanti di selezione vengono utilizzati all'interno dei diversi menù per visualizzare e/o impostare i vari parametri personalizzabili come indicato nelle diverse sezioni del presente manuale.

In qualsiasi momento è possibile inoltre controllare la temperatura Comfort preimpostata premendo una sola volta i tasti  o . Ogni ulteriore successiva pressione cambierà la temperatura impostata.

NOTA: La temperatura misurata tramite il sensore interno al prodotto indica sempre la temperatura ambiente nelle immediate vicinanze del prodotto e potrebbe differire dalla temperatura misurata con altri strumenti in altre aree della stanza. Questa differenza può dipendere da vari fattori, come ad esempio:

- La posizione dell'installazione: alcune aree della stanza possono risentire di correnti o sacche d'aria calda che possono modificare la misurazione del sensore;
- L'installazione su un muro perimetrale esterno, che essendo normalmente più freddo dei muri interni, può provocare una misurazione più bassa della temperatura rispetto alla temperatura ambiente reale;
- Un carico eccessivo di salviette sulla barra di supporto può ostruire il flusso d'aria calda, provocando una misurazione della temperatura più alta rispetto alla reale temperatura;
- Condizioni instabili: ogni valutazione deve essere fatta in condizioni stabili di funzionamento. Per questo motivo la temperatura Comfort non dovrebbe essere cambiata prima che siano trascorsi 60 minuti dalla precedente modifica. Non è possibile infatti valutare se la temperatura ambiente è mantenuta correttamente dal prodotto se il livello di temperatura è continuamente modificato in un breve periodo di tempo.

Se la differenza tra la temperature impostata e la temperature ambiente è rilevata in condizioni di stabilità, calcolate tale differenza e quindi aumentate o diminuite il livello di temperature Comfort sul prodotto dell'esatto valore della differenza calcolata.

PULSANTE OK



Il pulsante OK viene utilizzato all'interno dei diversi menu per confermare le impostazioni eseguite.

PULSANTE BOOST



Il pulsante di Boost permette di attivare il funzionamento temporizzato per 15 minuti alla massima potenza senza il controllo del termostato. Durante questo funzionamento il display mostra in modo alternato la scritta "Boost" e il tempo rimanente. Al termine di questo funzionamento forzato il termoventilatore torna alla modalità di funzionamento precedente l'attivazione.

7. RISOLUZIONE DEI PROBLEMI

- In caso di surriscaldamento, il protettore di sicurezza all'interno del prodotto disattiva sia la resistenza che il motore. In questo caso:
 - Spegnerne il termoventilatore e lasciarlo raffreddare per circa 15/20 minuti;
 - Assicurarsi che il filtro antipolvere non sia ostruito e pulire se necessario. Ricordarsi di ricollocarlo nella sua posizione originaria prima di riattivare il prodotto;
 - Eliminare ogni possibile causa di surriscaldamento (es.: ostruzioni in corrispondenza della griglia di uscita dell'aria, residui di sporczia sul prodotto);
 - Riaccendere il termoventilatore e controllare il corretto funzionamento.
- Se i comandi touch screen del prodotto non rispondono alla pressione digitale o non funzionano correttamente, spegnere il termoventilatore per almeno 30 secondi tramite l'interruttore elettromeccanico posto sul lato sinistro del prodotto.

8. MANUTENZIONE

- Questo prodotto non richiede manutenzione speciale.
- Pulire il prodotto con un panno asciutto almeno una volta ogni 6 mesi.
- In caso il prodotto debba essere riparato, rivolgersi ad un centro di assistenza qualificato.
- In caso di sostituzione del cavo di alimentazione, utilizzare un tipo 2x1,00mm² H05VV-F <HAR>. Tale sostituzione deve essere effettuata da personale tecnico qualificato e mai dall'utente finale per evitare un danneggiamento del prodotto e ogni rischio per la persona.

9. COMUNICAZIONI DI LEGGE



Tutela dell'ambiente e riciclaggio

Affinché il vostro apparecchio non subisca danni durante il trasporto, esso è stato imballato con cura. Per contribuire alla tutela del nostro ambiente, vi chiediamo di smaltire in modo appropriato il materiale utilizzato per l'imballaggio dell'apparecchio.

Smaltimento degli apparecchi usati

Gli apparecchi che recano il contrassegno riportato a fianco non devono essere smaltiti insieme ai rifiuti urbani, ma vanno raccolti e smaltiti separatamente. Lo smaltimento degli apparecchi usati va eseguito a regola d'arte, in conformità con le prescrizioni e leggi vigenti localmente in materia.

Informazioni obbligatorie per gli apparecchi per il riscaldamento d'ambiente locale elettrici

Identificativo del modello: WINDY					
Dato	Sim-bolo	Valore	Unità	Dato	Unità
Potenza termica				Tipo di potenza termica, solo per gli apparecchi per il riscaldamento d'ambiente locale elettrici ad accumulo (indicare una sola opzione)	
Potenza termica nominale	P_{nom}	1,8	kW	controllo manuale del carico termico, con termostato integrato	no
Potenza termica minima (indicativa)	P_{min}	1,0	kW	controllo manuale del carico termico con riscontro della temperatura ambiente e/o esterna	no
Massima potenza termica continua	$P_{max,c}$	1,8	kW	controllo elettronico del carico termico con riscontro della temperatura ambiente e/o esterna	no
Consumo ausiliario di energia elettrica				potenza termica assistita da ventilatore	no
Alla potenza termica nominale	$e_{l,max}$	0,000	kW	Tipo di potenza termica/controllo della temperatura ambiente (indicare una sola opzione)	
Alla potenza termica minima	$e_{l,min}$	0,000	kW	potenza termica a fase unica senza controllo della temperatura ambiente	no
In modo stand-by	$e_{l,SB}$	0,00053	kW	due o più fasi manuali senza controllo della temperatura ambiente	no
				con controllo della temperatura ambiente tramite termostato meccanico	no
				con controllo elettronico della temperatura ambiente	no
				con controllo elettronico della temperatura ambiente e temporizzatore giornaliero	no
				con controllo elettronico della temperatura ambiente e temporizzatore settimanale	si
				Altre opzioni di controllo (è possibile selezionare più opzioni)	
				controllo della temperatura ambiente con rilevamento di presenza	si
				controllo della temperatura ambiente con rilevamento di finestre aperte	si
				con opzione di controllo a distanza	no
				con controlli di avviamento adattabile	no
				con limitazione del tempo di funzionamento	no
				con termometro a globo nero	no
Contatti	Ermete Giudici S.p.A. - via L. da Vinci, 27 - 20090 Segrate (MI) Italy				

Before operating the heater, please read these instructions thoroughly to avoid damage and hazardous situations. Any use of this heater other than that stipulated in this instruction manual may cause fire, electric shock or injury, and voids all warranties.

Warranty does not apply to any defect, deterioration, loss, injury or damage caused by, or as a result of, the misuse or abuse of this heater. The rights dictated by State law are not prejudiced. None of the terms of this warranty are to be taken as excluding any conditions or warranties implied by State law, which cannot be excluded or modified.

Before any operation remove the packaging and check product integrity. In case of defects or damages do not try to repair it yourself but contact your dealer.

Do not let children play with the packaging and protect the environment by disposing of the packaging in accordance with the national regulations for waste processing.

1. FOR YOUR SAFETY

- This appliance is intended for normal household use and not for use in commercial/industrial environment, in vehicles or on board ships or aircrafts.
- This appliance can be used by children aged from 8 years and above and persons with reduced physical, sensory or mental capabilities or lack of experience and knowledge if they have been given supervision or instruction concerning use of the appliance in a safe way and understand the hazards involved. Children shall not play with the appliance. Cleaning and user maintenance shall not be made by children without supervision.
- Children of less than 3 years should be kept away unless continuously supervised.
- Children aged from 3 years and less than 8 years shall only switch on/off the appliance provided that it has been placed or installed in its intended normal operating position and they have been given supervision or instruction concerning use of the appliance in a safe way and understand the hazards involved. Children aged from 3 years and less than 8 years shall not plug in, regulate and clean the appliance or perform user maintenance.
- **CAUTION — Some parts of this product can become very hot and cause burns. Particular attention has to be given where children and vulnerable people are present.**
- Make sure that your supply rating corresponds to what specified on the rating plate: 230V~, 50Hz.
- This heater is water resistant to IPX4. It can therefore be used in bathrooms or other areas subject to humidity AS LONG AS IT

IS NOT INSTALLED WITHIN THE PERIMETER OF BATH TUBS OR SHOWERS. This means that it cannot be installed in the areas marked as VOLUME 1 in picture 1.

- During function, place the heater in a safe position:
 - at least 1m far from inflammable objects or furnitures;
 - leaving not less than 1m of free space in front of the heater;
 - not located immediately below a socket-outlet.
- Do not leave animals or children touch or play with the appliance. Pay attention! The air outlet grille gets hot during operation (more than 90°C)
- **WARNING: In order to avoid overheating, do not cover the heater.** Do not hang anything on the heater and do not cover it while it's working. This is clearly written on the cover of the product or shown by the symbol



- Do not use the heater in rooms with explosive gas or while using inflammable solvents or varnish or glues.
- If the cordset is damaged and you have to change it, do not do the job yourselves! Take the product to an after sales authorised repair centre or to a person with similar skill and knowledge, in order to avoid any risk of danger.
- The appliance must be positioned so that the plug is always accessible.
- Do not mount the product on walls made of synthetic material.

2. WALL MOUNTING

- Only fix the heater in vertical position with the air outlet grid downward;
- This heater is fitted with a double electrical insulation circuit (class II) and therefore does not require an earth connection.
- This heater must be correctly installed in compliance with the regulations in force in the country of installation.
- In wet spaces like bathrooms or kitchens, the connection terminal must be installed at least 25 cm above the floor. The electrical connection to the power supply must also be fitted with a two-pole switch with a minimum gap between the contacts that allows complete disconnection according to excess voltage III category conditions.
- To choose the best installation position please consider that the sensor is able to detect movements in the areas shown in picture 2. Place the heater in the best position to detect people inside the room and to be clear from any object that may interfere with the sensor's beam. Detection is more efficient when people move in front of the product instead towards it.
- Always make observe the minimum distances from walls, furniture and/or objects, as indicated in picture 3. Never install the product so that the distance between the floor and the lower side of the product is less than 600 mm:
 - Drill three 6 mm diameter holes in the wall, as shown in picture 4

- Insert the three wall plugs supplied with the product
- Insert the 2 upper screws, contained in the same bag, taking care to leave a distance of 8 mm between the head of the screws and the wall;
- Gripping the heater firmly, hook it onto the two screws; CAUTION! Before releasing the heater make sure it is attached to the 2 screws.
- Then secure the product with the lower screw.

3. TOWELS HOLDER (ON APPLICABLE VERSIONS)

- Before installing the wall-mounted fan heater it is necessary to fix the towel bar supplied separately from the product. To this purpose:
 - Remove the 2 plastic covers as shown in picture 5;
 - Fasten the bar to the fan heater with the 3 screws supplied as shown in picture 6;
 - Replace the 2 plastic covers as shown in picture 7;
 - Fix the plastic covers using the 2 supplied screws as shown in figure 7.
- Please do not push or embed towel close to the air outlet grid (picture 9) but place them as shown in picture 8.

4. FILTER

- This product is fitted with a filter to protect the heating element from dust and dirt.
- The filter is removable to be easily cleaned with water (picture 10).
- To keep the heater in perfect condition, clean the filter once every six months REMEMBERING TO PUT IT BACK AGAIN AFTERWARDS.
- Every 120 working hours, the user is notified of the need to clean the filter on the back of the product. The warning is given in the form of a running message on the display:
“CLEAN FILTER - PULIRE FILTRO”
- Even when the display is showing the message above, the product goes on working in the mode active when the notification appears.
- If any key is pushed the text is removed from the display and the built-in counter is reset.

5. COMMAND DESCRIPTION AND FUNCTIONING

- The heater is fitted with a double pole electromechanical ON/OFF switch on its left side. Switching off the product the supply voltage is disconnected from all the internal components.
- The following controls are available on the front panel (picture 11):
 - A - Presence Sensor
 - B - Anti-freeze mode LED indicator
 - C - Eco mode led indicator
 - D - Comfort mode led indicator
 - E - Open window detection LED indicator
 - F - Display
 - G - Boost function
 - H - Ok/confirm
 - I - Show and increase
 - J - Show and decrease
 - K - Mode
 - L - Menu
 - M - Stand-by

This fan heater features a presence sensor and an automatic power management function.

The presence sensor allows a reduced energy consumption, lowering automatically the ambient temperature when no presence is detected in the room for at least 10 minutes. Once someone is detected, Windy comes automatically back to the set comfort temperature. The automatic electronic power selection, instead, manages the consumption through an accurate and comfortable regulation keeping constant the selected temperature - according to what has previously been set on the electronic thermostat.

The product can be used choosing between 4 different operating modes:

- ANTI-FREEZE
- PROGRAMMED
- AUTOMATIC
- BASIC

Anti-freeze mode

The thermostat is set to keep 7 ± 3 °C. The function is activated manually or automatically when no presence in the room is detected for at least 36 hours. In this case, as soon as a presence is detected again, the product will automatically set the automatic mode.

Programmed mode

The product can be programmed by selecting, for each day of the week, which of the 5 preset profiles you want to use. During all the operating time in programmed mode, the presence sensor is deactivated so that the product can correctly follow the temperature profile set by the user.

In Programmed mode there is also a special function - which can be activated at the user's choice - allowing the detection of the eventual opening of a window and switching to the Anti-freeze mode to minimize energy waste.

Automatic Mode

The product is set to work at a comfort temperature whenever someone is detected in the room. Should no one be detected in the room for at least TEN minutes, the heater will automatically set the Eco mode (3,5°C less than the set Comfort temperature). Should no one be detected in the room for more than 36 hours, the heater will automatically set the Anti-freeze mode (7°C). In case someone should be detected again for at least 2 minutes, the product will automatically increase the temperature to the comfort level.

In automatic mode is also available a special feature, which is activated at user's choice, which allows to detect the possible opening of a window and to switch to the Anti-freeze mode to minimize energy waste.

Basic Mode

The product works in Comfort mode. The presence detection is **disabled** and doesn't affect the set temperature as in Automatic mode.

In Automatic mode is also available a special feature, which is activated at user's choice, which allows to detect the possible opening of a window and to switch to Anti-freeze mode to minimize energy waste.

6. USING THE FAN HEATER

MAIN ON/OFF SWITCH
(placed on the left side of the product)



The power supply of the product is controlled by an electromechanical ON/OFF switch. Switching off the fan heater will cut off the power to the electronic board causing - after 30 minutes of power supply absence - the loss of every stored information. We recommend to use this switch only when you are not using the product for long periods. Instead, it is possible to use the on/stand-by key for any short-term interruption, so that no stored setting will get lost.

At first use of the product or in case of over 30 minutes power loss, when the product turns on the display shows 00:00 and begins counting the time starting from this value.



Should no adjustment be made within 15min after power up, the product will automatically switch to Anti-freeze mode with the lighting up of the corresponding LED light.

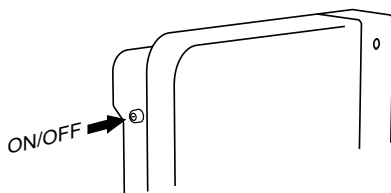

STAND-BY BUTTON



Use the  button to switch On or set in Stand-by the product. When ON is pressed the set working temperature LED lights up.



ECO



Example of activation in Comfort.

MENU BUTTON



The  button allows access to the product settings - time, day, weekly program and open window detection adjustment.

Time setting





Hour

Activate time display/change

by pressing the  button until the word "Hour" appears.
After 3 seconds:

00:00

The 2 digits representing the hour blink



Select the current hour by using the  or  key

Press the OK key to confirm



2:00

The 2 digits representing the minutes blink

Select the current minutes by using the  or  key

Press the OK key to confirm



Day of the week setting





day

Activate day of the week display/change

by pressing the  button until the word "day" appears.
After 3 seconds:

Mo

The 2 digits representing the day blink

Select the current day by using the  or  key

Press the OK key to confirm



Weekly program setting

The programming function allows you to choose - for each day of the week - one of the following three preset operating program:

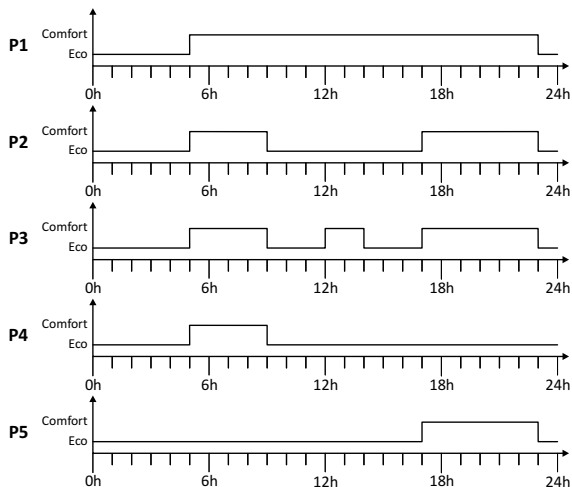



Prog

Activate programming display/change

by pressing the  button until the writing "Prog" appears. After 3 seconds:

Mo:P1

The 2 digits representing the first day blink



Select the day by using the  and  keys

Press the OK key to confirm



Mo:P1

The 2 program digits blink



Select the desired program by using the  and  keys

Press the OK key to confirm



Mo:P1

The 2 digits representing the selected day blink again to proceed with selecting another day



Select the day by using the  and  keys

Press the OK key to confirm



Tu:P2

The 2 program digits blink

Select the desired program by using the  and  keys

Press the OK key to confirm



Proceed like this for all the days you wish to view and/or modify.

End

At the end of the procedure, after the last day - Sunday - is displayed, press the  button again allows to terminate the programming. The message "End" appears on the display.

Press the OK key to exit the programming



At any time it is possible to exit by pressing the key  to save your changes.

Open window detection

This function makes it possible to detect an open window and automatically activate the Anti-freeze operating mode. When the function is enabled and ready a LED lights up under the corresponding icon. The simultaneous lighting of the LED lights under the Anti-freeze and window symbols indicates that an open window has been detected and the Anti-freeze mode has been automatically set.



The reset of the normal functioning is not automatic but is achieved by pressing one of the product buttons.



Correct operation of this function may depend on where the radiator is positioned in the room, the presence of draughts, the outside temperature, and how long the window remains open.



OPEN

Activate open window detection function display/change by pressing the  button until the writing "OPEN Window" appears

OPEN



The writing scrolls on the display

Press the OK key to view the function status



YES

"YES" indicates the function is active



Activate or deactivate the function by using the  and  keys

Press the OK key to confirm



NO

"NO" indicates the function is deactive

Activate or deactivate the function by using the  and  keys

Press the OK key to confirm



Pressing the  button allows to select one of the 4 operating modes described in paragraph 5.



Fros

ANTI-FREEZE mode

The thermostat temperature is automatically set to 7 ± 3 ° C.

The LED light corresponding to the Anti-freeze mode lights up.

In this mode the open window detection function is disabled.



Prog

PROGRAMMED mode

The fan heater reaches and keeps the temperature set in the weekly program (MENU button).

The LED light corresponding to the Comfort or Eco mode lights up according to the settings for the current time and day.

In this mode the open window detection function can be enabled or disabled using the MENU button ("OPEN Window" setting).

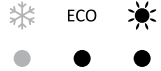

Auto

AUTOMATIC mode

The fan heater reaches and keeps the Comfort temperature and automatically switches first to the Eco and then to the Anti-freeze mode when no presence is detected. The LED light corresponding to the Comfort, Eco or Anti-freeze mode lights up according to the information received by the presence sensor.

In this mode the open window detection function can be enabled or disabled using the MENU button ("OPEN Window" setting).

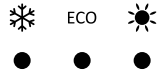

BASE

BASIC mode

The fan heater reaches and keeps the Comfort temperature by deactivating the presence sensor.

The LED light corresponding to the Comfort mode lights up.

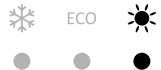

In this mode the open window detection function can be enabled or disabled using the MENU button ("OPEN Window" setting).



SELECTION BUTTONS



Selection buttons are used within the menus to display and/or set the several customizable parameters as shown in the various sections of this manual.

You can check the set Comfort temperature at any time by pressing a single time the  or  key. A further pression will modify the set temperature.

Note: The temperature measured by the inner sensor of the product is representative of the ambient temperature nearby it and it may differ from the temperature measured using other instruments in other areas of the room. That difference may depend on many factors including, for example:

- the installation position: some areas of the room may be affected by drafts or hot air sacs that modify the sensor measurement;
- an external wall fixation: it may imply a temperature measurement lower than the real room temperature;
- an excessive towels load on the support bar may obstruct the airflow. As a result the sensor may measure a temperature higher than the real room temperature;
- unstable conditions: any evaluation must be done in stable working conditions. For this purpose Comfort temperature should be changed only 60min after a previous change. In fact, it is not possible to evaluate if the room temperature is correctly maintained by the product when the Comfort temperature gets repeatedly changed in a short time. If the difference between set temperature and room temperature is detected in stable working conditions, measure the difference and then increase or decrease the comfort temperature on the product of the exact measured difference value.

OK BUTTON



The OK button is used in the various menus to confirm the chosen settings.

BOOST BUTTON



The Boost button allows to activate the timed operation for 15 minutes at maximum power without the thermostat control. During this operation the display shows alternately the word "BooS" and the remaining time. At the end of this forced operation, the fan heater returns to the previous operating mode.

7. TROUBLESHOOTING

- In the event of overheating, the safety device on the appliance automatically disabled the heating elements and motor. In this case:
 - Turn off the fan heater and allow it to cool down for about 15/20 minutes.
 - Make sure the dust filter is not totally obstructed and clean if necessary. Remember to put it back again afterwards.
 - Eliminate any other possible reasons for overheating (e.g.: obstructions in front of the air inlet/outlet grilles, build-ups of dirt).
 - Turn on the fan heater again and check its correct functioning.
- If the touch control commands are blocked or don't answer properly to digital pressure, turn off the heater for at least 30sec using the electromechanic switch on the left side of the heater. Then turn on the heater using the same switch.

8. MAINTENANCE

- This product does not require any special maintenance.
- Clean the product with a dry cloth at least once every 6 months.
- If the product requires repairing, contact an authorised technical service centre.
- When replacing the power cable, use a 2x1,00mm² H05VV-F <HAR> type. This operation must be performed by qualified personnel and never by the user in order - in order to avoid product damages and safety hazards.

9. LEGAL NOTICE



Environment and recycling

To prevent the product from being damaged during transport, it has been carefully packed. To contribute to environmental protection, we ask you to dispose of the packaging material properly.

Recycling of obsolete appliances

Appliances with this label must not be disposed off with the general waste. They must be collected separately and disposed off according to local regulations. Used appliances disposal must be carried out carefully and in accordance with local waste disposal regulations.

Information requirements for electric local space heaters

Model identifier(s): WINDY					
Item	Symbol	Value	Unit	Item	Unit
Heat output				Type of heat input, for electric storage local space heaters only (select one)	
Nominal heat output	P_{nom}	1,8	kW	manual heat charge control, with integrated thermostat	no
Minimum heat output (indicative)	P_{min}	1,0	kW	manual heat charge control with room and/or outdoor temperature feedback	no
Maximum continuous heat output	$P_{max,c}$	1,8	kW	electronic heat charge control with room and/or outdoor temperature feedback	no
Auxiliary electricity consumption				fan assisted heat output	no
At nominal heat output	eI_{max}	0,000	kW	Type of heat output/room temperature control (select one)	
At minimum heat output	eI_{min}	0,000	kW	single stage heat output and no room temperature control	no
In standby mode	eI_{SB}	0,00053	kW	Two or more manual stages, no room temperature control	no
				with mechanic thermostat room temperature control	no
				with electronic room temperature control	no
				electronic room temperature control plus day timer	no
				electronic room temperature control plus week timer	yes
				Other control options (multiple selections possible)	
				room temperature control, with presence detection	yes
				room temperature control, with open window detection	yes
				with distance control option	no
				with adaptive start control	no
				with working time limitation	no
				with black bulb sensor	no
Contact details	Ermete Giudici S.p.A. - via L. da Vinci, 27 - 20090 Segrate (MI) Italy				

Lees deze instructies zorgvuldig door voordat u het product in gebruik neemt zodat schade of het ontstaan van gevaarlijke situaties wordt voorkomen. Elk gebruik van het product dat verschillend is dan dit vermeld in deze handleiding kan brand, elektrische gevaren of letsels veroorzaken en laat elke garantie vervallen.

De garantie geldt niet voor defect, kwaliteitsverlies, verlies, letsel of schade dat voortvloeit uit onjuist gebruik van het product. Alle rechten door de wet voorzien blijven gewaarborgd. Geen enkele verzekeringsvoorwaarde kan de verzekeringsvoorwaarden die geregeld zijn door de wetgeving van het land uitsluiten of wijzigen.

Voor elke bewerking, de verpakking zorgvuldig verwijderen en de perfecte integriteit van het product controleren. Als gebreken of schade zou worden vastgesteld, de apparatuur niet installeren of proberen te herstellen, maar contact opnemen met uw wederverkoper. De verpakking buiten het bereik van kinderen houden en de onderdelen afvoeren overeenkomstig de geldende voorschriften.

1. VOOR UW VEILIGHEID

- Dit product is voor huishoudelijk gebruik en is niet geschikt voor gebruik in commerciële of industriële omgevingen of op voertuigen, boten of vliegtuigen.
- Het apparaat kan gebruikt worden door kinderen vanaf 8 jaar oud en door personen met verminderde lichamelijke, zintuiglijke of geestelijke vermogens, of met gebrek aan ervaring of de nodige kennis, mits deze onder toezicht staan of nadat deze instructies kregen voor een veilig gebruik van het apparaat en betreffende het begrip van de gevaren die inherent zijn aan het apparaat. Kinderen mogen niet met het apparaat spelen. De reiniging en het onderhoud bestemd om te worden uitgevoerd door de gebruiker mag niet uitgevoerd worden door kinderen zonder toezicht.
- Kinderen jonger dan 3 jaar mogen niet in de nabijheid van het product komen zoniet constant onder toezicht.
- De kinderen tussen 3 en 8 jaar mogen het toestel alleen in- en uitschakelen zolang dit geïnstalleerd en geplaatst is volgens de normale gebruiksomstandigheden en zolang ze adequaat onder toezicht staan of instructies ontvangen met betrekking tot het juiste en veilige gebruik van het product en zolang ze het gevaar ervan begrepen hebben.
- Kinderen tussen 3 en 8 jaar mogen het product niet aansluiten, bijstellen, reinigen of het onderhoud ervan uitvoeren.
- **LET OP: Sommige delen van dit product kunnen zeer heet worden en brandwonden veroorzaken. Er moet bijzondere aandacht besteed worden in het bijzijn van kinderen of kwetsbare mensen.**

- Zorg ervoor dat de netvoeding overeenkomt met de gegevens van de gegevensplaat : 230V ~, 50 Hz.
- Deze heteluchtverwarmer heeft een zekere mate van bescherming IPX4 en kan daarom gebruikt worden in badkamers, zolang deze niet GEïNSTALLEERD WORDT BINNEN DE OMTREK VAN HET BAD OF DE DOUCHE.
- Het product mag niet geïnstalleerd worden in gebieden aangeduid als volume 1 in het schema van figuur 1.
- Tijdens het plaatsen van de heteluchtverwarmer dient men deze te plaatsen op een veilige plaats of:
 - op tenminste 1 meter van brandbare voorwerpen of meubels
 - mits de luchtuitlaatrooster vrij te laten: er mag geen enkel voorwerp aanwezig zijn binnen 1 meter van de uitlaatrooster;
 - niet direct geplaatst onder een stekker.
- Zorg ervoor dat dieren of kinderen de heteluchtverwarmer niet aanraken. Opgelet! Tijdens het functioneren kan de uitlaatrooster heel warm worden (meer dan 90° C);
- BELANGRIJK: om oververhitting te vermijden het product nooit afdekken.
- Plaats nooit voorwerpen of dekens op de verwarmers terwijl in gebruik.
- Dit is duidelijk op het apparaat geschreven en getoond door het symbool



- Gebruik de heteluchtverwarmer niet in kamers verzadigd met explosieve gassen, dampen gegenereerd door oplosmiddelen en verf of brandbare dampen/gassen.
- Als het snoer beschadigd is en deze moet vervangen worden doe dit dan niet zelf, breng de heteluchtverwarmer naar een geautoriseerd reparatiecentrum omdat de tussenkomst vereist is van gespecialiseerde personeel om elk risico op schade te vermijden.
- De heteluchtverwarmer moet zodanig worden geplaatst dat de stekker altijd toegankelijk is.
- Het product niet installeren op muren in kunststof.

2. MONTEREN AAN DE MUUR

- Installeer de heteluchtverwarmer rechtop met de luchtuitlaatrooster naar beneden gericht.
- Dit apparaat is dubbel geïsoleerd (klasse II) de aarde- aansluiting is dus niet vereist is.
- Deze heteluchtverwarmer moet worden geïnstalleerd in overeenstemming met de regels die gelden in het land van installatie.
- In vochtige ruimten zoals badkamers en keukens moet de verbinding met het elektriciteitsnet ten minste 25 cm boven de grond gebeuren. De apparaten voor het loskoppelen van de netvoeding moeten bij overspanning categorie III toelaten de volledige ont koppeling te garanderen.
- Om te beslissen over de ideale installatie, dient men in gedachten te houden dat de sensor de bewegingen detecteert binnen het gebied beschreven in figuur 2. Installeer de verwarming in de beste positie die mensen in de kamer detecteert en die vrij veld heeft met betrekking tot voorwerpen die kunnen interfereren met de straal van de sensor zelf. Het detecteren is vooral efficiënt wanneer mensen zich voor het product bewegen in plaats van te bewegen in de richting ervan.
- Het apparaat moet worden geïnstalleerd aan de muur, met inachtneming van de minimale afstanden tot het plafond, vloer en zijwanden afgebeeld in figuur 3. Nooit het product installeren op een afstand van de vloer die minder is dan 600 mm:
 - Maak 3 gaten van diameter 6 mm in de muur met inachtneming van de afstanden die zijn aangegeven in figuur 4;
 - De drie meegeleverde schroeven inbrengen
 - Breng de 2 schroeven in aan de bovenkant, meegeleverd in hetzelfde zakje, erop lettend dat 8 mm wordt gelaten tussen de kop van de schroef en de muur;
 - Koppel het product aan de 2 schroeven die u heeft vastgeschroefd en houd het product steeds stevig in uw handen; OPGELET! Vooraleer het product los te laten ervoor zorgen dat dit goed gekoppeld is aan de 2 schroeven;
 - Maak het product uiteindelijk vast met de derde schroef onderaan.

3. HANDDOEKHOUDER (OP TOEPASSELIJKE VERSIES)

- Alvorens de heteluchtverwarmer aan de muur te installeren is het nodig de handdoekhouder vast te maken die afzonderlijk wordt geleverd bij het product. Daartoe:
 - De 2 plastic deksels verwijderen zoals afgebeeld in figuur 5;
 - Bevestig de houder aan de heteluchtverwarmer met de 3 meegeleverde schroeven zoals getoond in figuur 6;
 - Plaats de plastic deksels opnieuw zoals weergegeven in figuur 7;
 - Bevestig de plastic deksels met de 2 meegeleverde schroeven zoals getoond in figuur 7.
- De handdoeken moeten correct worden geplaatst op de houder, zoals aangegeven in figuur 8 en NIET zoals in figuur 9, om oververhitting en storingen te voorkomen.

4. FILTER

- Uw product is uitgerust met een filter om de verwarmingselementen te beschermen tegen stof en vuil.
- De filter is eenvoudig verwijderbaar en kan gewassen worden met water (figuur 10).
- Voor een goede werking van het product moet de filter ten minste een keer schoongemaakt worden om de zes maanden ER WORDT AAN HERHINNERD DAT DEZE TERUG MOET WORDEN GEPLAATST NA HET WASSEN.
- Om de 120 werkuren wordt de gebruiker gewaarschuwd van de noodzaak om de filter aan de achterkant van het product te reinigen. De melding wordt gedaan via het display van de bewegende teksten:
"CLEAN FILTER - PULVERE FILTER"
- Ook al beeldt het display het bovenvermelde af, toch blijft het product werken in actieve modus vanaf het begin van de waarschuwing.
- Door op een willekeurige toets te drukken wordt de waarschuwing gewist en wordt de interne teller op nul gezet.

5. BESCHRIJVING VAN DE BESTURINGSELEMENTEN EN DE WERKING

- De heteluchtverwarmer is uitgerust met een aan/uitschakelaar gelegen aan de linkerkant. Bij het uitschakelen van het product blijven de interne elektrische componenten niet langer onder spanning.
- De volgende besturingselementen zijn geïntegreerd op de voorzijde van het product (figuur 11):
 - A - Aanwezigheidssensor
 - B - Antivries modus led-indicator
 - C – Eco-modus led-indicator
 - D – Comfort-modus led-indicator
 - E - Detectie open venster led-Indicator
 - F - Display
 - G - Boost functie
 - H - Ok/bevestigen
 - I - Weergave en verhogen
 - J - Weergave en verminderen
 - K - Modus
 - L - Menu
 - M - Stand-by
- Deze heteluchtverwarmer bevat een aanwezigheidssensor en een systeem van automatisch energiebeheer.
- De aanwezigheidssensor kan een reductie in energieverbruik toelaten door het automatisch verlagen van de omgevingstemperatuur wanneer de kamer onbezet is gedurende ten minste 10 minuten. De terugkeer naar de comfort-temperatuur gebeurt automatisch van zodra er opnieuw een aanwezigheid gedetecteerd wordt.
- De automatische energieschakelaar laat optimaal beheer van het verbruik toe en een nauwkeurige afstelling van het comfortniveau met behoud van constante temperatuur automatisch geselecteerd overeenkomstig hetgeen ingesteld is op de elektronische thermostaat.
- Het product kan worden gebruikt door te kiezen uit 4 verschillende modi:
 - ANTIVRIES
 - GEPROGRAMMEERD
 - AUTOMATISCH
 - BASE

Antivries Modus

De thermostaat wordt ingesteld om 7 ± 3 °C te behouden. De functie wordt handmatig of automatisch geactiveerd als geen enkele aanwezigheid in de kamer wordt gedetecteerd gedurende ten minste 36 uur. In dit geval, zal het product automatisch de automatische modus instellen van zodra opnieuw een aanwezigheid gedetecteerd wordt.

Geprogrammeerde Modus

Het product kan geprogrammeerd worden door voor elke dag van de week een van de 5 vooraf ingestelde profielen in te stellen indien u dit wenst. Tijdens de volledige geprogrammeerde modus wordt de aanwezigheidsdetector uitgeschakeld om ervoor te zorgen dat het product correct het temperatuurprofiel dat werd ingesteld door de gebruiker kan volgen.

In geprogrammeerde modus is ook een speciale functie beschikbaar die kan worden geactiveerd naar keuze van de gebruiker, waardoor de mogelijke opening van een raam kan worden gedetecteerd en de werking in antivries modus wordt gebracht om energieverstopping te minimaliseren.

Automatische Modus

Het product is ingesteld om te werken bij een comfort-temperatuur telkens iemand gedetecteerd wordt in de kamer. In geval van het niet-detecteren van eventuele aanwezigheid gedurende meer dan 10 minuten zet het toestel automatisch de eco-temperatuur in ($3,5$ °C minder dan de ingestelde comfort-temperatuur). Als het niet-detecteren van aanwezigheid meer dan 36 uur duurt, stelt de kachel automatisch de antivries-functie in (7 °C). Als het product een aanwezigheid zou detecteren gedurende ten minste 2 minuten, keert de temperatuur van het toestel automatisch terug naar het ingestelde comfort niveau.

In automatische modus is ook een speciale functie beschikbaar die kan worden geactiveerd naar keuze van de gebruiker, waardoor de mogelijke opening van een raam kan worden gedetecteerd en de werking in antivries modus wordt gebracht om energieverstopping te minimaliseren.

Base Modus

Het product werkt in comfort modus en de aanwezigheidsdetectie wordt uitgeschakeld en heeft geen invloed op de ingestelde temperatuur zoals bij de automatische modus.

In base modus is ook een speciale functie beschikbaar die kan worden geactiveerd naar keuze van de gebruiker, waardoor de mogelijke opening van een raam kan worden gedetecteerd en de werking in antivries modus wordt gebracht om energieverstopping te minimaliseren.

6. GEBRUIK VAN DE HETELUCHTVERWARMER

AAN/UIT-TOETS

(geplaatst aan de linkerkant van het product)



De voeding van het product wordt gecontroleerd door een elektromechanische aan/uit-knop.

Het uitschakelen van het product via deze knop zorgt voor de onderbreking van de voorziening van het elektronisch paneel, na 30 minuten onderbreking, het verlies van de ingevoerde instellingen.

Wij raden u aan deze knop te gebruiken als je het product niet hoeft te gebruiken voor een langere tijd en in plaats daarvan gebruik te maken van de voorste On/ Stand-by bediening, in geval van een korte onderbreking van het gebruik van het product, zodat uw eerder ingevoerde instellingen niet verloren gaan.

Bij het eerste gebruik van het product, of in geval van uitval van de elektriciteitsvoorziening voor een periode langer dan 30 minuten, wanneer de heteluchtverwarmer ingeschakeld wordt verschijnt op het display 00:00 en begint de klok de tijd te tellen.



In het geval geen instelling wordt ingegeven binnen 15 minuten na het inschakelen stelt het product automatisch de antivries-functie in, met inschakeling van de corresponderende led.

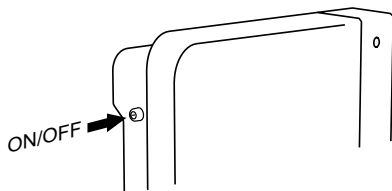

STAND-BY-TOETS



De toets  gebruiken om het product op te starten of in Stand-by te brengen. Bij het opstarten licht de led die overeenkomt met de actieve werkingstemperatuur op.



ECO



Voorbeeld inschakeling in Comfort.

MENU - TOETS



De toets  maakt toegang mogelijk tot alle verschillende instellingen van het product of de instelling van het uur, de dag, het weekprogramma en tot de functie van detectie van een open venster.

Instelling van het uur



Hour

Activeer het afbeelden/wijzigen van het uur via het drukken op de toets  totdat "Hour" wordt afgebeeld.

Na 3 seconden:

00:00

De 2 cijfers van het uur knipperen



Kies het huidige uur bij middel van de toetsen  en 

De toets OK Indrukken om te bevestigen



21:00

De 2 cijfers van de minuten knippen

De huidige minuten selecteren bij middel van de toetsen  en 

De toets OK Indrukken om te bevestigen



Instellen van de dag van de week





day

Activeer het afbeelden/wijzigen van de weekdag door het drukken op  totdat het opschrift "day" verschijnt. Na 3 seconden:

Mo

De 2 cijfers van de dag knippen

De huidige dag selecteren bij middel van de toetsen  en 

De toets OK Indrukken om te bevestigen



Het weekprogramma instellen

De programma-functie maakt het mogelijk voor elke dag van de week te kiezen, welke van de volgende drie vooraf ingestelde werkingsprogramma's u wilt gebruiken:

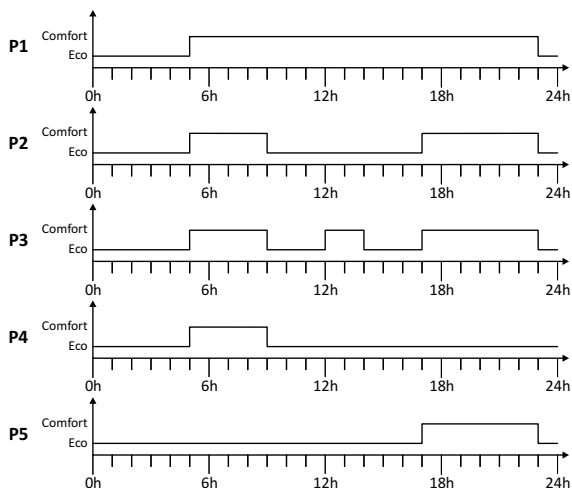



Prog

Activeer het afbeelden/wijzigen van de programmering door het drukken op  Totdat het opschrift "Prog" verschijnt. Na 3 seconden:

Mo:P1

De 2 cijfers van de dag knippen



Kies de gewenste dag bij middel van de toetsen  en 

De toets OK Indrukken om te bevestigen



Mo:P1

De 2 cijfers van het programma knippen



Selecteer het gewenste programma bij middel van de toetsen  en 

De toets OK Indrukken om te bevestigen



Mo:P1

De 2 cijfers van de dag, net ingesteld knipperen zodat een andere dag kan worden begonnen

Selecteer de gewenste dag bij middel van de toetsen  en 

De toets OK Indrukken om te bevestigen



Tu:P2

De 2 cijfers van het programma knipperen

Selecteer het gewenste programma bij middel van de toetsen  en 

De toets OK Indrukken om te bevestigen



Op die manier verdergaan voor alle dagen die men wenst af te beelden/te wijzigen.

End

Op het einde van de procedure, na afbeelding van de laatste dag (zondag), Maakt een laatste druk op toets  mogelijk de programmering te beëindigen. Op het display verschijnt "End".

De toets OK indrukken om uit de programmering te gaan



Men kan op elk moment de programmering verlaten door het drukken op de toets .

Instellen van de detectie venster open

Deze functie maakt het identificeren mogelijk van een open venster en stelt automatisch de wijze van antivries functioneren in. Het gelijktijdig oplichten van de LED's onder het antivriessymbool en onder het raamsymbool duidt aan dat een open venster werd gedetecteerd en dat automatisch de antivries modus werd ingesteld.



Het hervatten van de normale werking gebeurt niet automatisch, maar wordt verkregen door op een van de product-codes te drukken.



De juiste werking van deze functie kan afhangen van de positionering van het product in de kamer, van de aanwezigheid van tocht, van de buiten temperatuur en van het tijdstip van de opening van het venster.



OPEN

Het afbeelden/wijzigen van de status van activering van de detectiefunctie Van het open venster door op toets  te drukken totdat "OPEN Window" wordt afgebeeld.

OPEN



Het opschrift verschijnt op het display

De toets OK indrukken om te bevestigen



YES

Het opschrift "YES" betekent dat de functie actief is



De functie activeren of deactiveren bij middel van de toetsen  en 

De toets OK Indrukken om te bevestigen



NO

Het opschrift "NO" betekent dat de functie niet actief is

De functie activeren of deactiveren bij middel van de toetsen  en 

De toets OK Indrukken om te bevestigen



Het drukken op de toets  maakt het mogelijk een van de 4 werkingsmodi beschreven in paragraaf 5 te selecteren.



Fros

ANTIVRIES modus

De thermostaat is automatisch ingesteld op een temperatuur van $7 \pm 3^\circ \text{C}$.

De LED overeenkomend met de antivriestemperatuur licht op.

In deze modus is de functie ter detectie van open venster uitgeschakeld.

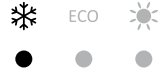

Prog

GEPROGRAMMEERDE Modus

De heteluchtverwarmer werkt om de temperatuur te bereiken en te handhaven ingesteld in het weekprogramma (zie MENU-toets).

De led overeenkomstig de comfort- of eco-temperatuur licht op afhankelijk van de instellingen voor het huidige uur en dag.

In deze modus kan de functie ter detectie van open venster in- of uitgeschakeld worden bij middel van de MENU-toets (instelling "OPEN U.ndau").

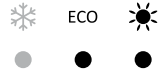

Auto

AUTOMATISCHE Modus

De heteluchtverwarmer werkt om de comfort-temperatuur te bereiken en gaat automatisch eerst naar de eco-temperatuur en dan naar de antivries temperatuur als niets gedetecteerd wordt in de omgeving.

De led overeenkomstig met de Comfort, Eco, of Antivriestemperatuur licht op naargelang de informatie ontvangen van de aanwezigheidssensor.

In deze modus kan de functie ter detectie van open venster in- of uitgeschakeld worden bij middel van de MENU-toets (instelling "OPEN U.ndau").

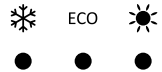

BASE

BASE Modus

De heteluchtverwarmer werkt om de comfort-temperatuur te bereiken en te behouden door het uitschakelen van de aanwezigheidssensor.

De led overeenkomstig met de comfort-temperatuur licht op.

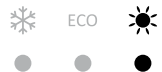

In deze modus kan de functie ter detectie van open venster in- of uitgeschakeld worden bij middel van de MENU-toets (instelling "OPEN U.ndau").



SELECTIETOETSEN



De selectietoetsen worden gebruikt binnen verschillende menu's om de verschillende aanpasbare parameters af te beelden en/of in te stellen zoals aangegeven in de verschillende delen van deze handleiding.

Op elk gewenst moment kunt u ook de vooraf ingestelde comfort-temperatuur controleren door eenmaal te drukken op de toetsen  of . Elke bijkomende druk zal de ingestelde temperatuur wijzigen.

OPMERKING: De temperatuur gemeten door de interne sensor van het product geeft altijd de kamertemperatuur aan in de onmiddellijke nabijheid van het product en kan afwijken van de temperatuur gemeten met andere instrumenten in andere gebieden van de kamer. Dit verschil kan afhangen van verschillende factoren, zoals bijvoorbeeld:

- De locatie van de installatie: sommige gebieden van de kamer kunnen worden beïnvloed door stromen of warme luchtzakken die de meting van de sensor kan wijzigen;
- Installatie op een externe omtrekmuur, die normaal gesproken de koudste van de binnenmuren is. Dit kan een temperatuurmeting veroorzaken lager dan de werkelijke omgevingstemperatuur;
- Een zware belasting van handdoeken op de houder kan de doorstroming van hete lucht belemmeren, wat een meting van de temperatuur veroorzaakt hoger dan de werkelijke temperatuur;
- Onstabiele omstandigheden : elke evaluatie moet worden uitgevoerd in stabiele bedrijfsomstandigheden. Om deze reden mag de comfort-temperatuur niet worden gewijzigd voordat de 60 minuten zijn verstreken sinds de vorige wijziging.

Het is niet mogelijk te beoordelen of de kamertemperatuur correct door het product onderhouden wordt als het temperatuurniveau continu gewijzigd wordt in een korte periode van tijd.

Als het verschil tussen de ingestelde temperatuur en de kamertemperatuur in stabiele omstandigheden wordt gemeten, bereken dan dit verschil en verhoog of verlaag vervolgens het niveau van de comfort-temperatuur op het product van de exacte waarde van het berekende verschil.

OK-TOETS



De OK-toets wordt gebruikt binnen de verschillende menus om de gemaakte instellingen te bevestigen.

BOOST-TOETS



De Boost-toets maakt het mogelijk een getimed werking gedurende 15 minuten op volle kracht in te schakelen zonder controle van de thermostaat. Tijdens deze werking toont het display afwisselend de opschriften "BooS" en de overblijvende tijd. Aan het einde van deze versterkte werking keert de heteluchtverwarmer opnieuw naar de bedrijfsmodus voorgaand aan de inschakeling.

7. OPLOSSEN VAN PROBLEMEN

- In geval van oververhitting, schakelt de veiligheid binnen binnenin het product zowel de weerstand als de motor uit. In dit geval:
 - De heteluchtverwarmer uitschakelen en laten afkoelen gedurende ongeveer 15/20 minuten;
 - Zorg ervoor dat de stoffilter niet geblokkeerd is en reinig indien nodig. Vergeet niet deze in de oorspronkelijke positie terug te plaatsen voordat het product opnieuw wordt ingeschakeld;
 - Elke mogelijke oorzaak van oververhitting verwijderen (vb.: obstructies in overeenstemming met de luchtuitlaatrooster, vuilresten op het product);
 - Schakel de heteluchtverwarmer opnieuw in en controleer de juiste werking.
- Als de touch screen bedieningen van het product niet reageren op vingerdrukken of niet goed werken, schakel de verwarming dan minimaal 30 seconden uit door middel van de elektromechanische schakelaar aan de linkerkant van het product.

8. ONDERHOUD

- Dit product heeft geen speciaal onderhoud nodig.
- Reinig het product met een droge doek ten minste eenmaal elke 6 maand.
- Als het product moet worden gerepareerd, neem contact op met een gekwalificeerde servicecenter.
- Bij vervanging van de stroomkabel, dient men een kabel van het soort 2 x 1,00 mm 2 H05VV-F <HAR> te gebruiken. Deze vervanging moet gebeuren door gekwalificeerd technisch personeel en nooit door de eindgebruiker teneinde beschadiging van het product te vermijden en alle risico's voor de persoon.

9. WETTELIJKE VERMELDINGEN



Bescherming van het milieu en recycling

Om ervoor te zorgen dat uw toestel niet beschadigd wordt tijdens het transport, werd het met zorg ingepakt. Om bij te dragen tot de bescherming van ons milieu, vragen wij de verpakking gebruikt voor de verpakking van het product op geschikte wijze af te voeren.

Verwijdering van gebruikte apparatuur

De apparaten die het hiernaast afgebeelde merkteken dragen mogen niet worden verwijderd als stedelijk afval maar worden verzameld om afzonderlijk te worden verwijderd. De verwijdering van gebruikte apparatuur moet vakkundig worden uitgevoerd in overeenstemming met de geldende lokale voorschriften en wetten.

Verplichte informatie voor de lokale elektrische ruimteverwarmingstoestellen

Typeaanduiding(en): WINDY					
Item	Symbol	Waarde	Eenheid	Item	Eenheid
Warmteafgifte				Type warmte-input, uitsluitend voor elektrische warmteopslagtoestellen (selecteer één)	
Nominale warmteafgifte	P_{nom}	1,8	kW	Handmatige sturing van de warmteopslag, met geïntegreerde thermostaat	neen
Minimale warmteafgifte (indicatief)	P_{min}	1,0	kW	Handmatige sturing van de warmteopslag, met kamer- en/of buitentemperatuurfeedback	neen
Maximale continue warmteafgifte	$P_{max,c}$	1,8	kW	Elektronische sturing van de warmteopslag, met kamer- en/of buitentemperatuurfeedback	neen
Aanvullend elektriciteitsverbruik				Door een ventilator bijgestane warmteafgifte	neen
Bij nominale warmteafgifte	$e_{l,max}$	0,000	kW	Type warmteafgifte/sturing kamertemperatuur (selecteer één)	
Bij minimale warmteafgifte	$e_{l,min}$	0,000	kW	Eentrapswarmteafgifte, geen sturing van de kamertemperatuur	neen
In stand-bymodus	$e_{l,SB}$	0,00053	kW	Twee of meer handmatig in te stellen trappen, geen sturing van de kamertemperatuur	neen
				Met mechanische sturing van de kamertemperatuur door thermostaat	neen
				Met elektronische sturing van de kamertemperatuur	neen
				Elektronische sturing van de kamertemperatuur plus dag-tijdschakelaar	neen
				Elektronische sturing van de kamertemperatuur plus week-tijdschakelaar	ja
				Andere sturingsopties (meerdere selecties mogelijk)	
				Sturing van de kamertemperatuur, met aanwezigheidsdetectie	ja
				Sturing van de kamertemperatuur, met openraamdetectie	ja
				Met de optie van afstandsbediening	neen
				Met adaptieve sturing van de start	neen
				Met beperking van de werkingstijd	neen
				Met black-bulbsensor	neen
Contactgegevens	Ermete Giudici S.p.A. - via L. da Vinci, 27 - 20090 Segrate (MI) Italië				



WINDY_R3_20180919