

SILK

BADKAMERRADIATOR

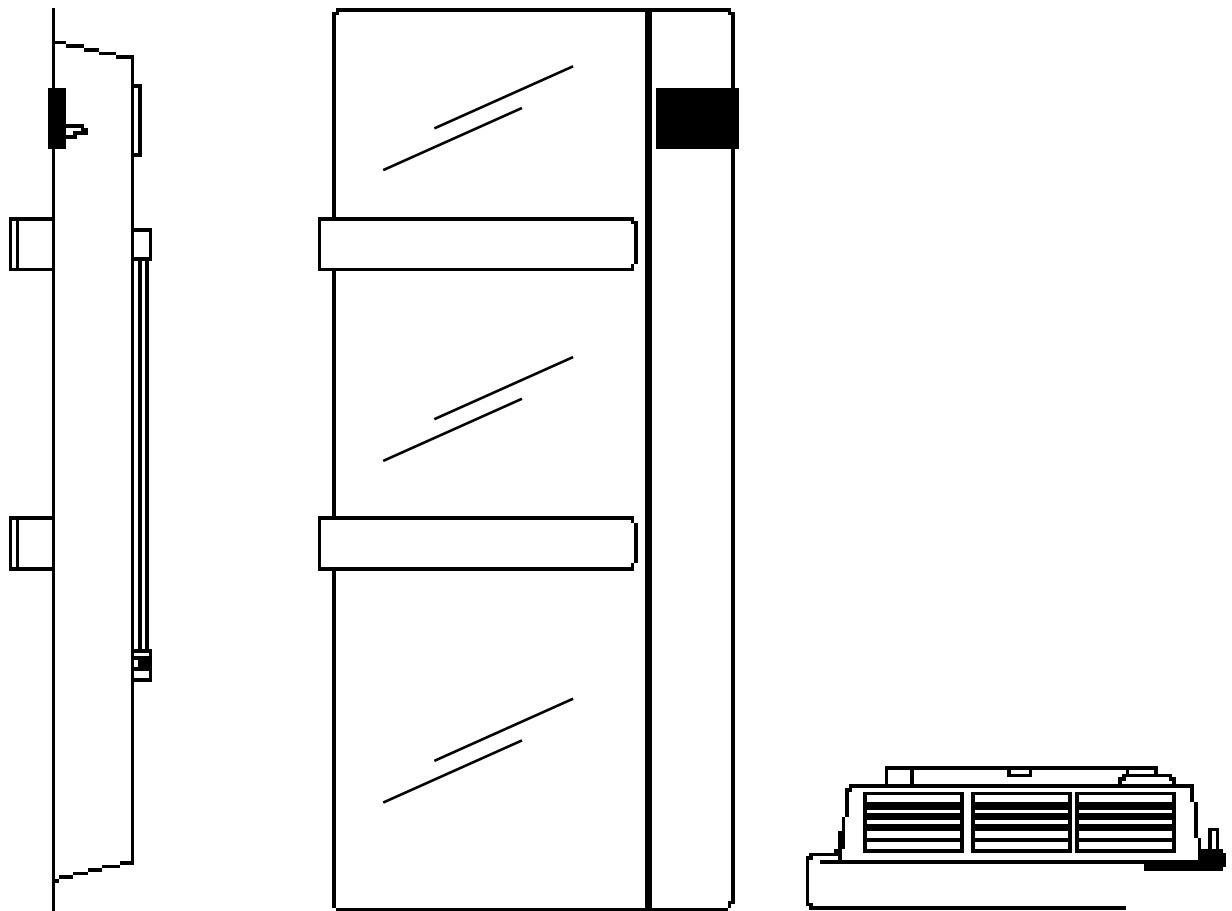

HANDLEIDING

ELEKTRISCH VERWARMEN

E-COMFORT SILK | ONSEN

HANDLEIDING

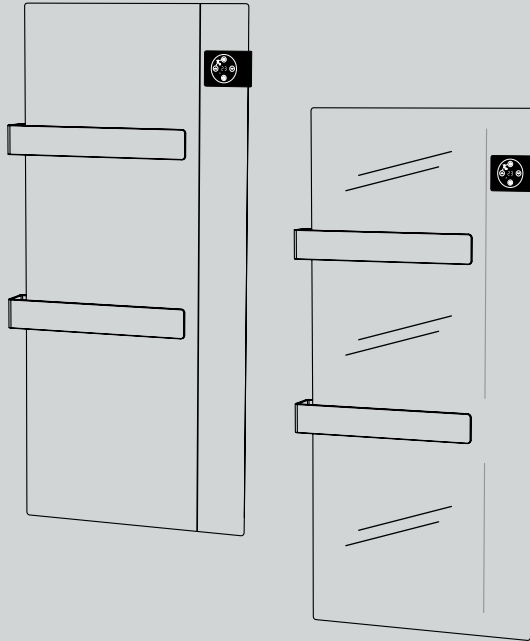

- IT Leggere il manuale d'uso. Conservare con cura le istruzioni per ogni futura consultazione.
- NL Bewaar deze instructies op een veilige plaats voor toekomstig gebruik.
- EN Please retain these instructions in a safe place for further reference.
- DE Bitte lesen Sie dieses Benutzerhandbuch. Bewahren Sie die Anweisungen zum späteren Nachschlagen sorgfältig auf.
- PL Zachowaj tą instrukcję, może być użyteczna w przyszłości.
- RO Pastrati instructiunile pentru consultari ulterioare.
- FR Lisez le manuel d'utilisation. Ranger soigneusement les instructions afin de pouvoir les consulter par la suite.

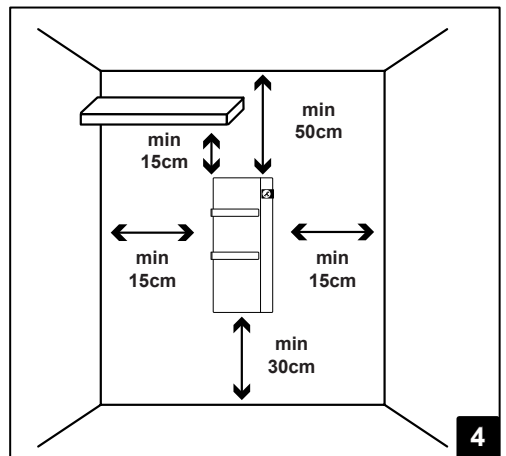
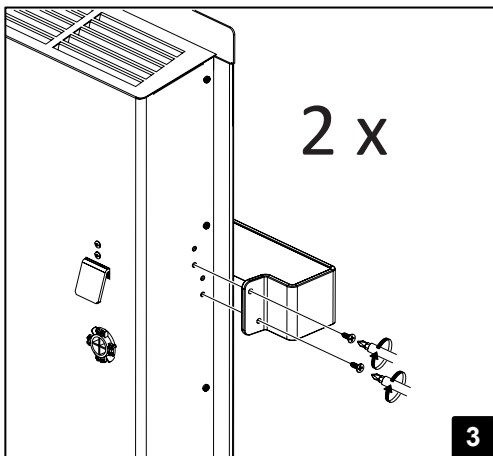
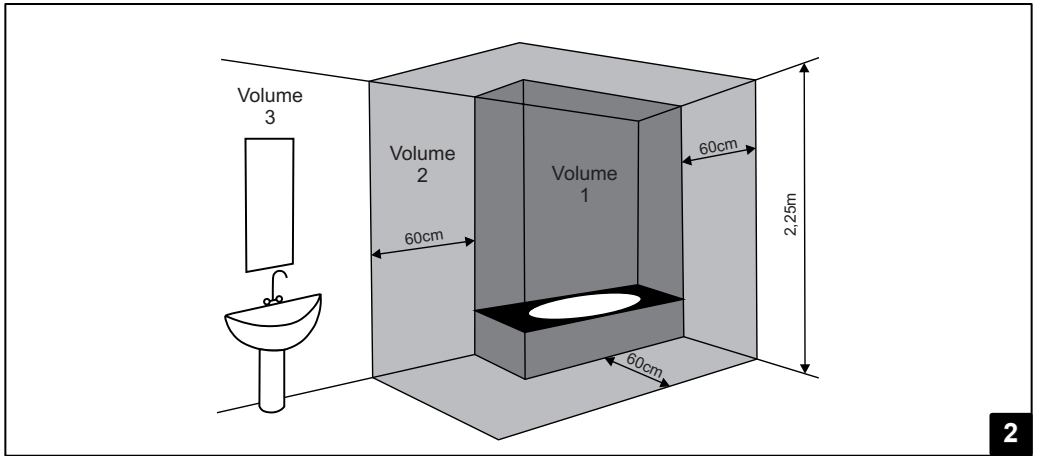
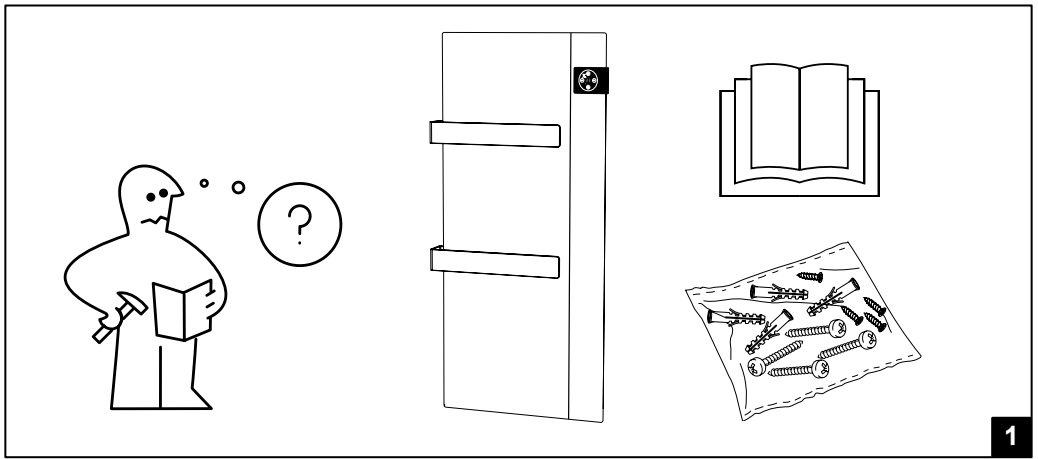

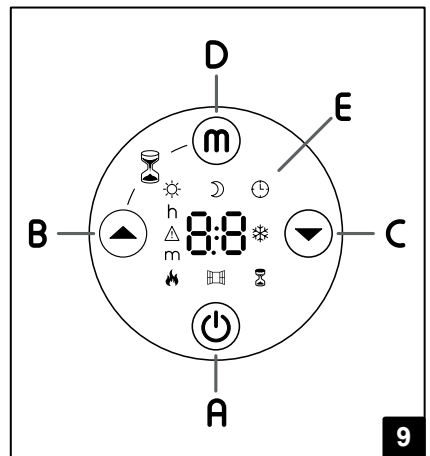
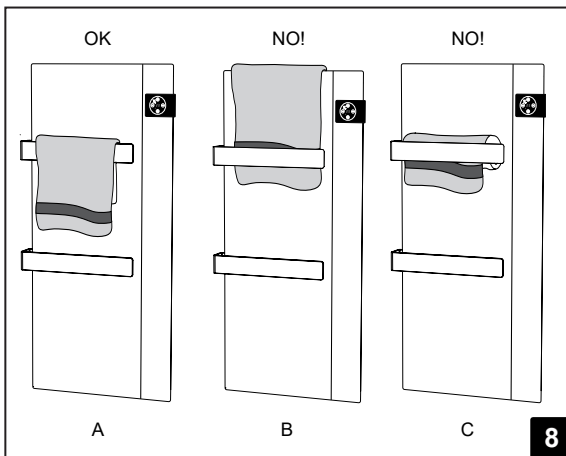
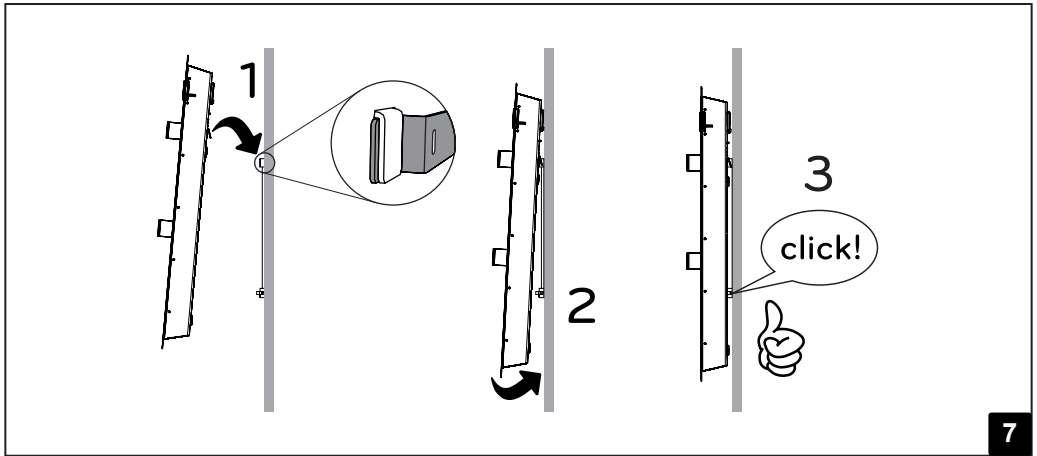
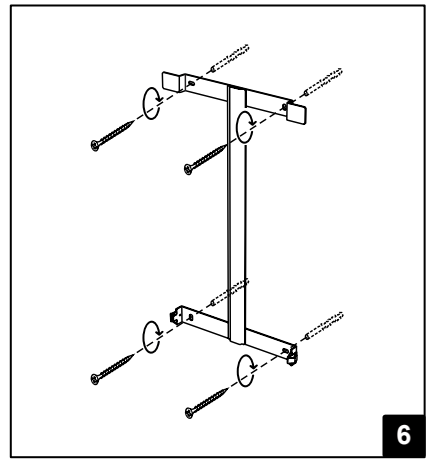
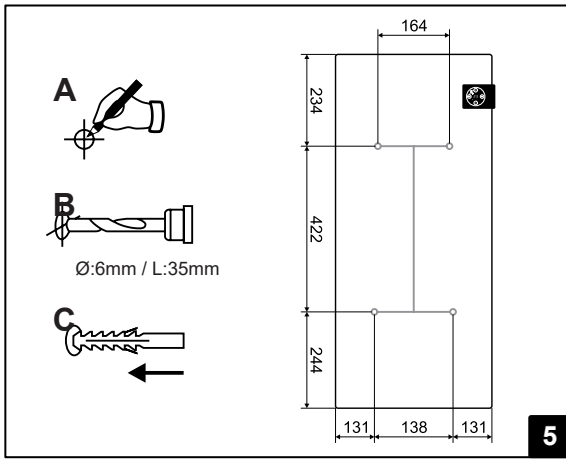

Si prega di leggere attentamente queste istruzioni, prima di utilizzare il prodotto, in modo da evitare danneggiamenti o comunque il verificarsi di situazioni di pericolo. Qualsiasi utilizzo del prodotto diverso da quanto indicato nel presente manuale può causare incendi, pericoli elettrici o ferite e rende nulla qualsiasi garanzia.

La garanzia non si applica ad alcun difetto, deterioramento, perdita, ferimento o danneggiamento riconducibili ad un uso non corretto del prodotto. Rimangono garantiti tutti i diritti di legge in materia. Nessuna condizione di garanzia può escludere o modificare le condizioni di garanzia regolamentate da leggi dello Stato che non possono essere a nessun titolo escluse o modificate.

Prima di ogni operazione, rimuovere con cura l'imballo e controllare la perfetta integrità del prodotto. Nel caso si evidenziasero dei difetti o danni, non installare né cercare di riparare l'apparecchiatura, ma rivolgersi al rivenditore. Non lasciare l'imballo alla portata dei bambini e smaltirne le parti in conformità con le disposizioni vigenti.

1. PER LA VOSTRA SICUREZZA

- Questo prodotto è per uso domestico e non è adatto per l'utilizzo su veicoli, imbarcazioni o aeromobili.
- L'apparecchio può essere utilizzato da bambini di età non inferiore a 8 anni e da persone con ridotte capacità fisiche, sensoriali o mentali, o prive di esperienza o della necessaria conoscenza, purché sotto sorveglianza oppure dopo che le stesse abbiano ricevuto istruzioni relative all'uso sicuro dell'apparecchio e alla comprensione dei pericoli ad esso inerenti. I bambini non devono giocare con l'apparecchio. La pulizia e la manutenzione destinata ad essere effettuata dall'utilizzatore non deve essere effettuata da bambini senza sorveglianza.
- I bambini di età inferiore a 3 anni non devono avvicinarsi al prodotto se non costantemente supervisionati.
- I bambini di età compresa fra 3 e 8 anni possono solamente accendere e spegnere l'apparecchio purché esso sia stato installato e posizionato secondo le normali condizioni d'uso e loro siano supervisionati o adeguatamente istruiti riguardo al corretto e sicuro utilizzo del prodotto e ne abbiano compresa la pericolosità. I bambini di età compresa fra 3 e 8 anni non possono collegare il prodotto, regolarlo, pulirlo o effettuare manutenzione.
- **ATTENZIONE: Alcune parti di questo prodotto possono diventare molto calde e causare bruciature. Particolare attenzione deve essere prestata in presenza di bambini o persone vulnerabili.**
- Assicuratevi che l'alimentazione di rete corrisponda ai dati di targa: 230-240V~, 50Hz.
- Questo radiatore ha un grado di protezione IPX4 e può quindi esse-

re utilizzato nei bagni PURCHE' NON SIA INSTALLATO ENTRO IL PERIMETRO DELLA VASCA O DELLA DOCCIA. Il prodotto non può quindi essere installato nelle aree indicate come Volume 1 nello schema di figura 2.

- Durante il funzionamento collocate il radiatore in una posizione sicura ovvero:
 - ad almeno 1m da oggetti infiammabili o mobili;
 - lasciando libera la griglia di uscita dell'aria: nessun oggetto deve essere presente nel raggio di 1m dalla griglia di uscita;
 - mai posizionato immediatamente sotto ad una presa di corrente.
- Non lasciate che animali o bambini giochino o tocchino il radiatore. Attenzione! Durante il funzionamento la griglia di uscita dell'aria può diventare molto calda (oltre 90°C);
- Non utilizzate il radiatore in stanze sature di gas esplosivi, di vapori generati da solventi e vernici o comunque di vapori/gas infiammabili.
- Se il cavo è danneggiato e dovete sostituirlo non eseguite questa operazione da soli, riportate il radiatore ad un centro di riparazioni autorizzato perché è richiesto l'intervento di personale specializzato al fine di evitare qualunque rischio di danneggiamento.
- Il radiatore deve essere posizionato in modo tale che la presa di alimentazione sia sempre raggiungibile.
- Non installate il prodotto su pareti di materiale sintetico.
- ATTENZIONE: Non utilizzate il radiatore in stanze di piccole dimensioni quando esse sono occupate da persone non in grado di uscire dalla stanza da sole a meno che non siano sotto la supervisione di qualcuno responsabile per la loro sicurezza;
- ATTENZIONE: Per ridurre il rischio di incendio tenete tessuti, tende o qualsiasi altro materiale infiammabile ad almeno 1m di distanza dalla griglia di uscita dell'aria.
- ATTENZIONE: Questo apparecchio è destinato solo all'essiccazione dei tessuti lavati ad acqua.

2. IL VOSTRO PRODOTTO

- Il prodotto viene fornito dotato di (figura 1):
 - N°1 staffa metallica per l'installazione a muro (fissata al radiatore);
 - N°4 tasselli in nylon da 8x50mm;
 - N°4 viti per tasselli da 5x60mm;
 - N° 2 barre porta salviette
 - N°4 viti per fissaggio barre da 3,9x13mm;
- Qualora il prodotto sia danneggiato o qualche accessorio mancante contattate immediatamente il vostro rivenditore.

3. MONTAGGIO A MURO

- Utilizzate il prodotto solo in posizione verticale.
- Questo radiatore è in doppio isolamento elettrico (classe II) pertanto la connessione di terra non è richiesta.
- Questo radiatore deve essere installato seguendo le norme in vigore nel paese di installazione.
- In ambienti umidi come bagni e cucine la connessione alla rete elettrica deve essere ad almeno 25 cm di altezza dal suolo. I dispositivi di disconnessione dalla rete di alimentazione devono consentire la disconnessione completa nelle condizioni della categoria di sovratensioni III.
- Se si desidera applicare al prodotto una o entrambe le barre porta salviette, prima di fissare l'apparecchio al supporto murale, utilizzare le viti in dotazione come illustrato in figura 3.
- L'apparecchio deve essere installato a muro, rispettando le distanze minime dal soffitto, dal pavimento e dalle pareti laterali indicate in figura 4. Mai installare il prodotto ad una distanza dal pavimento inferiore a 30cm:
 - Rimuovete la staffa per l'installazione a muro fissata sul posteriore del radiatore facendo scattare le 2 molle inferiori;
 - Marcate con una matita la posizione dei punti di fissaggio (figura 5).
 - Realizzate i fori nei 4 punti precedentemente marcati ed inserite i tasselli in plastica.
 - Fissate la staffa a muro usando le 4 viti in dotazione (figura 6).
 - Agganciate il prodotto alla staffa iniziando dai 2 punti di fissaggio superiori e poi facendo scattare in posizione i 2 punti di fissaggio inferiori (figura 7).
 - Qualora sia necessario rimuovere il prodotto dalla staffa, si raccomanda di sganciare per primi i due punti di fissaggio inferiori e successivamente quelli superiori.

4. SALVIETTE

- Posizionare sempre le salviette ben distese sopra la barra di supporto (figura 8-A);
- Non disporre le salviette sopra al prodotto (figura 8-B);
- Non arrotolare le salviette fra la barra e la superficie frontale (figura 8-C).

5. DESCRIZIONE DEI COMANDI E DEL FUNZIONAMENTO

- I seguenti controlli sono integrati sul frontale del prodotto (figura 9):
 - A - Stand-by
 - B - Aumenta
 - C - Diminuisci
 - D - Modalità
 - E - Display

Il radiatore può essere fatto funzionare in 3 distinte modalità: automatica, programmata o antigelo:

Modalità Automatica

In questa modalità il prodotto funziona per raggiungere e mantenere la temperatura di Comfort impostata dall'utente. Un sistema di gestione automatico della potenza permette un controllo ottimale dei consumi ed una regolazione precisa del livello di comfort mantenendo automaticamente la temperatura selezionata costante nel tempo, in accordo con quanto è stato impostato sul termostato elettronico. In modalità automatica è inoltre disponibile una speciale funzione, attivabile a scelta dell'utente, che permette di rilevare l'eventuale apertura di una finestra e forzare il funzionamento in modalità Antigelo per limitare al massimo lo spreco di energia.

Modalità Programmata

Il prodotto può essere programmato, su base oraria, per ogni giorno della settimana. Per ogni ora di ogni giorno infatti è possibile definire la temperatura di riferimento da raggiungere/mantenere scegliendo fra le temperature di Comfort, Eco (il cui valore è pari alla temperatura di Comfort ridotta di 3,5°C) o Antigelo.



Per tutto il tempo di funzionamento in modalità programmata il rilevamento dell'apertura di una finestra viene disattivato affinché il prodotto possa correttamente seguire il profilo di temperature impostato dall'utente.

Modalità Antigelo

In questa modalità il termostato viene automaticamente impostato per mantenere 7±3°C.

6. UTILIZZO DEL RADIATORE

PULSANTE STAND-BY

Usare il pulsante  per accendere o mettere in Stand-by il prodotto. Quando il prodotto è in Stand-by sul display vengono visualizzati due trattini bianchi:

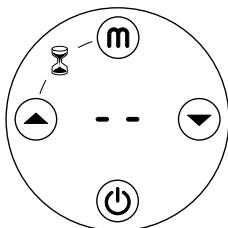

All'accensione il prodotto si attiva in modalità Automatica. La scritta "AU" viene visualizzata per 3 secondi sul display e, successivamente, viene mostrata la temperatura impostata:

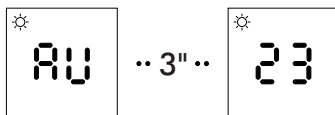



MODALITÀ DI FUNZIONAMENTO

Tramite il pulsante  è possibile variare la modalità di funzionamento fra automatica, programmata e antigelo come descritto al paragrafo 5.

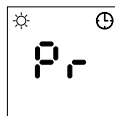

Premere il tasto  per passare dalla modalità automatica a quella programmata. Il display mostra la scritta "Pr".
Sul display si accendono anche il simbolo dell'orologio e l'icona relativa al modo di funzionamento previsto per l'ora e il giorno correnti (comfort, eco o antigelo).



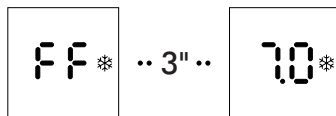

Premere il tasto  per passare dalla modalità programmata a quella antigelo. Il display mostra per 3 secondi la scritta "FF" e successivamente la temperatura prevista di 7.0°C (non modificabile). Sul display si accende anche il simbolo della modalità antigelo.



Premere nuovamente il tasto  per ritornare nella modalità automatica e ricominciare il ciclo.

IMPOSTAZIONI

I pulsanti ,  e , permettono di impostare l'ora e il giorno correnti, la temperatura di Comfort e di attivare o disattivare il rilevamento dell'apertura di una finestra. Il giorno "1" corrisponde al LUNEDÌ.



Premere il tasto  per almeno 3 secondi per visualizzare/modificare le impostazioni iniziando dall'orario.

Usare i tasti  e  per selezionare l'ora corrente.



Premere il tasto  per passare alla regolazione dei minuti.

Usare i tasti  e  per selezionare i minuti correnti.



Premere il tasto  per passare alla regolazione del giorno.

Usare i tasti  e  per selezionare il giorno corrente (1 = lunedì).

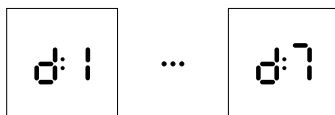

Premere il tasto  per passare all'impostazione di rilevamento dell'apertura di una finestra.

Usare i tasti  e  per attivare o disattivare il rilevamento dell'apertura di una finestra.

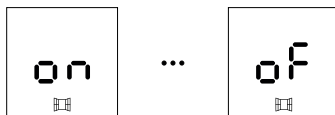

Premere il tasto  per concludere l'impostazione e tornare al normale funzionamento.

SENSORE FINESTRA APERTA

Questa funzione permette di rilevare l'apertura di una finestra e di impostare automaticamente il modo di funzionamento Antigelo. L'accensione della relativa icona nella parte bassa del display indica che la funzione è abilitata e pronta ad attivare la modalità antigelo qualora venga rilevata l'apertura di una finestra.

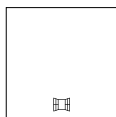

Qualora venga rilevata una brusca riduzione della temperatura durante il normale funzionamento del prodotto, viene attivata automaticamente la modalità antigelo per ridurre lo spreco di energia. Il display mostra la modalità antigelo e l'icona della finestra lampeggiante.

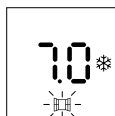



Il ripristino del normale funzionamento non è automatico ma si ottiene premendo uno qualsiasi dei tasti del prodotto.



Il corretto funzionamento di questa funzione può dipendere dal posizionamento del prodotto del locale, dalla presenza di spifferi, dalla temperatura esterna e dal tempo di apertura della finestra.

VISUALIZZARE / MODIFICARE LA TEMPERATURA COMFORT

La temperatura di Comfort preimpostata viene mostrata in modalità automatica e può essere modificata premendo i tasti  e . La temperatura di Eco, usata nella programmazione, non è modificabile ed è sempre uguale a quella di Comfort -3,5°C. La temperatura Antigelo è anch'essa fissa e pari a 7°C.

NOTA: La temperatura misurata tramite il sensore interno al prodotto indica sempre la temperatura ambiente nelle immediate vicinanze del prodotto e potrebbe differire dalla temperatura misurata con altri strumenti in altre aree della stanza.

Questa differenza può dipendere da vari fattori, come ad esempio:

- La posizione dell'installazione: alcune aree della stanza possono risentire di correnti o sacche d'aria calda che possono modificare la misurazione del sensore;
- L'installazione su un muro perimetrale esterno, che essendo normalmente più freddo dei muri interni, può provocare una misurazione più bassa della temperatura rispetto alla temperatura ambiente reale;
- Condizioni instabili: ogni valutazione deve essere fatta in condizioni stabili di funzionamento. Per questo motivo la temperatura Comfort non dovrebbe essere cambiata prima che siano trascorsi 120 minuti dalla precedente modifica. Non è possibile infatti valutare se la temperatura ambiente è mantenuta correttamente dal prodotto se il livello di temperatura è continuamente modificato in un breve periodo di tempo.



Se vi è differenza tra la temperatura impostata e la temperatura ambiente rilevata con altri strumenti in condizioni di stabilità, è possibile correggere la misura fatta dal termostato elettronico del prodotto. Questa operazione è particolarmente utile anche quando si installa il radiatore molto vicino al pavimento o al soffitto.

Per impostare questa correzione procedere come segue:



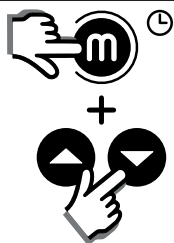
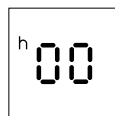

Premere e MANTENERE PREMUTO il tasto : sul display compare la visualizzazione dell'ora corrente.

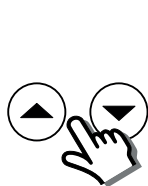
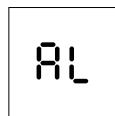

Continuando a tenere premuto il tasto  premere contemporaneamente anche i tasti  e . Sul display si visualizza per 2 secondi la scritta "AL" (allineamento) e, successivamente, il valore dell'allineamento inserito (il valore predefinito è 0).



Usare i tasti  e  per impostare l'allineamento desiderato scegliendo un valore compreso fra -5 e +5.

Esempio di allineamento:

Se il prodotto è stato impostato a 19°C ma nella stanza se ne misurano, in condizioni di stabilità, 20°C l'allineamento da inserire è pari a $20-19 = 1$;

Se, al contrario, il prodotto è impostato a 19°C ma nella stanza se ne misurano, per esempio, 17°C l'allineamento da impostare è pari a $17-19 = -2$.

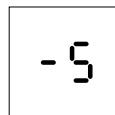

...

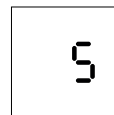

Premere il tasto  per concludere l'allineamento e tornare al normale funzionamento.

PROGRAMMAZIONE SETTIMANALE

La modalità Programmata permette di impostare, per ogni ora del giorno e per tutti i giorni della settimana in modo indipendente, la temperatura desiderata scegliendo fra quella di Comfort, quella di Eco (pari a quella di Comfort ridotta di 3,5°C) o quella di Antigelo. La sua attivazione si ottiene utilizzando il tasto  fino a visualizzare sul display la scritta "Pr". Se il prodotto è nuovo il profilo predefinito per il programma è il seguente:

Sempre Antigelo con attivazione della modalità comfort:

- dalle 06:00 alle 08:00 dal lunedì al venerdì;
- dalle 08:00 alle 10:00 il sabato e la domenica.

Quando si è in modalità programmazione si può attivare la visualizzazione/modifica del programma premendo insieme i tasti



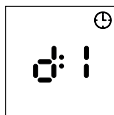

Il display visualizza il giorno 1 (lunedì).



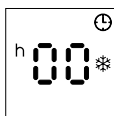

Premendo i tasti  e  si visualizzano le diverse ore del giorno iniziando da "00" (ora compresa fra le ore 00:00 e le 00:59).

La temperatura di riferimento impostata per l'ora selezionata è indicata dall'accensione dell'icona antigelo (temperatura di 7°C), di quella Eco (temperatura Eco = Comfort - 3,5°C) o di quella Comfort (temperatura Comfort impostata dall'utente).

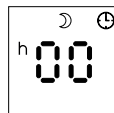
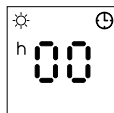
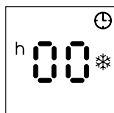

La temperatura desiderata può essere modificata premendo il tasto . L'accensione in sequenza delle icone sopra descritte indica la temperatura di riferimento.



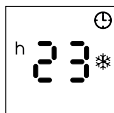

Usare i tasti  e  per visualizzare/modificare la temperatura impostata per ognuna delle ore del giorno 1, dall'ora 00 alle 23.

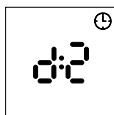

Giunti alle ore 23, la successiva pressione del tasto  permette di accedere alla programmazione del giorno 2.



A questo punto è possibile scegliere se visualizzare/modificare la temperatura delle singole ore del giorno 2 oppure impostare il

giorno 2 identico al giorno 1. Nel primo caso, usare i tasti  e  come già illustrato per il giorno 1, nel secondo è sufficiente

premere nuovamente il tasto . Così facendo il giorno 2 viene posto automaticamente uguale al giorno 1 e il sistema si porta all'inizio del giorno 3. Questa procedura può essere ripetuta fino alla programmazione del giorno 7.

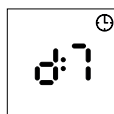
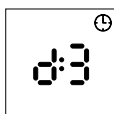

Al termine della programmazione del giorno 7, oppure in qualsiasi fase intermedia della programmazione, in seguito alla pressione

del tasto  si accede alla fase di salvataggio del programma. Sul display appare la scritta "OK" e si ha la memorizzazione del programma appena definito.







Nota bene:



- In ogni momento è possibile abbandonare la procedura di visualizzazione/modifica cancellando le modifiche non ancora salvate attendendo 30 secondi senza toccare alcun tasto;
- Durante la programmazione gli elementi riscaldanti vengono disattivati ed il radiatore non scalda.

FUNZIONE BOOST

La funzione di Boost permette di attivare il funzionamento temporizzato alla massima potenza senza il controllo del termostato. Al termine di questo funzionamento forzato il radiatore torna alla modalità di funzionamento precedente l'attivazione.

Per attivare la funzione premere contemporaneamente i tasti  e . La durata predefinita di 60min lampeggia sul display. La durata può essere scelta fra i valori di 60, 90 o 120minuti (2h) usando le frecce  e . Trascorsi 5 secondi dall'ultima selezione la funzione viene attivata.

Se il tempo rimanente è inferiore o uguale a 59min il display mostra i minuti di riscaldamento residui. Se superiore mostra i minuti residui preceduti dalla visualizzazione per 3sec della scritta "1h".

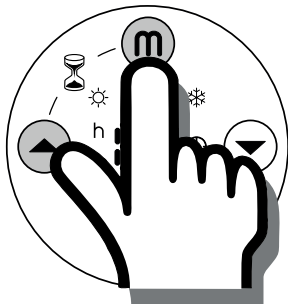

7. RISOLUZIONE DEI PROBLEMI

- In caso di surriscaldamento, il protettore di sicurezza all'interno del prodotto disattiva sia la resistenza. In questo caso:
 - Spegner il radiatore e lasciarlo raffreddare per circa 15/20 minuti;
 - Eliminare ogni possibile causa di surriscaldamento (ad esempio ostruzioni in corrispondenza della griglia di uscita dell'aria, asciugamani che coprono il prodotto ecc.);
 - Riaccendere il radiatore e controllare il corretto funzionamento.
- Se i comandi touch screen del prodotto non rispondono alla pressione digitale o non funzionano correttamente, spegnere il radiatore per almeno 1min e riprovare.

8. MANUTENZIONE

- Questo prodotto non richiede manutenzione speciale.
- Pulire il prodotto con un panno asciutto almeno una volta ogni 6 mesi.
- In caso il prodotto debba essere riparato, rivolgersi ad un centro di assistenza qualificato.
- In caso di sostituzione del cavo di alimentazione, utilizzare un tipo 2x1,00mm² H05V2V2-F <HAR>. Tale sostituzione deve essere effettuata da personale tecnico qualificato e mai dall'utente finale per evitare un danneggiamento del prodotto e ogni rischio per la persona.

9. COMUNICAZIONI DI LEGGE



Tutela dell'ambiente e riciclaggio

Affinché il vostro apparecchio non subisca danni durante il trasporto, esso è stato imballato con cura. Per contribuire alla tutela del nostro ambiente, vi chiediamo di smaltire in modo appropriato il materiale utilizzato per l'imballaggio dell'apparecchio.

Smaltimento degli apparecchi usati

Gli apparecchi che recano il contrassegno riportato a fianco non devono essere smaltiti insieme ai rifiuti urbani, ma vanno raccolti e smaltiti separatamente. Lo smaltimento degli apparecchi usati va eseguito a regola d'arte, in conformità con le prescrizioni e leggi vigenti localmente in materia.

Informazioni obbligatorie per gli apparecchi per il riscaldamento d'ambiente locale elettrici

Identificativo del modello: ONSEN					
Dato	Simbolo	Valore	Unità	Dato	Unità
Potenza termica				Tipo di potenza termica, solo per gli apparecchi per il riscaldamento d'ambiente locale elettrici ad accumulo (indicare una sola opzione)	
Potenza termica nominale	P_{nom}	0,75	kW	controllo manuale del carico termico, con termostato integrato	no
Potenza termica minima (indicativa)	P_{min}	0,75	kW	controllo manuale del carico termico con riscontro della temperatura ambiente e/o esterna	no
Massima potenza termica continua	$P_{max,c}$	0,75	kW	controllo elettronico del carico termico con riscontro della temperatura ambiente e/o esterna	no
Consumo ausiliario di energia elettrica				potenza termica assistita da ventilatore	no
Alla potenza termica nominale	$e_{l_{max}}$	0,000	kW	Tipo di potenza termica/controllo della temperatura ambiente (indicare una sola opzione)	
Alla potenza termica minima	$e_{l_{min}}$	0,000	kW	potenza termica a fase unica senza controllo della temperatura ambiente	no
In modo stand-by	$e_{l_{SB}}$	0,343	W	due o più fasi manuali senza controllo della temperatura ambiente	no
				con controllo della temperatura ambiente tramite termostato meccanico	no
				con controllo elettronico della temperatura ambiente	no
				con controllo elettronico della temperatura ambiente e temporizzatore giornaliero	no
				con controllo elettronico della temperatura ambiente e temporizzatore settimanale	si
				Altre opzioni di controllo (è possibile selezionare più opzioni)	
				controllo della temperatura ambiente con rilevamento di presenza	no
				controllo della temperatura ambiente con rilevamento di finestre aperte	si
				con opzione di controllo a distanza	no
				con controllo di avviamento adattabile	no
				con limitazione del tempo di funzionamento	no
				con termometro a globo nero	no
Contatti:	Ermete Giudici S.p.A. - via L. da Vinci, 27 - 20090 Segrate (MI) Italy				

Valori di riferimento a 230V 50Hz

Lees deze instructies zorgvuldig door voordat u het verwarmingstoestel gebruikt. Zo voorkomt u schade en gevaarlijke situaties. Enig gebruik anders dan beschreven in deze handleiding kan brand, elektrische schokken of letsel veroorzaken en leidt ertoe dat de garantie vervalt.

De garantie geldt niet voor eventuele defecten, verslechtering, verlies, letsel of schade veroorzaakt door of als gevolg van het verkeerde gebruik of misbruik van dit toestel. Aan rechten die voortvloeien uit nationale wetgeving wordt geen afbreuk gedaan. Geen van de garantiebepalingen sluit voorwaarden of garanties uit die in nationale wetgeving vastgelegd zijn en niet uitgesloten of gewijzigd mogen worden.

Verwijder vóór het gebruik de verpakking en controleer of het apparaat intact is. Neem in geval van defecten of schade contact op met de dealer. Probeer het apparaat niet zelf te repareren.

Laat kinderen niet met de verpakking spelen en bescherm het milieu door de verpakking overeenkomstig de nationale voorschriften voor afvalverwerking te verwijderen.

1. VOOR UW VEILIGHEID

- Dit apparaat is bedoeld voor normaal huishoudelijk gebruik en niet voor gebruik in voertuigen of aan boord van schepen of vliegtuigen.
- Dit apparaat kan worden gebruikt door kinderen vanaf 8 jaar en personen met verminderde lichamelijke, zintuiglijke of verstandelijke vermogens of een gebrek aan ervaring en kennis, mits ze onder toezicht staan of instructies hebben gekregen over hoe ze het apparaat op een veilige manier kunnen gebruiken en de risico's begrijpen. Kinderen mogen niet met het apparaat spelen. Reiniging of onderhoud mag niet door kinderen worden uitgevoerd, tenzij onder toezicht.
- Kinderen jonger dan 3 jaar moeten uit de buurt van het apparaat worden gehouden, tenzij er voortdurend toezicht is.
- Kinderen onger dan 8 jaar mogen het apparaat alleen in-/uitschakelen indien het op de beoogde, normale plek van gebruik is geplaatst of geïnstalleerd, en ze onder toezicht staan of instructies hebben gekregen over hoe ze het apparaat op een veilige manier kunnen gebruiken en de risico's begrijpen. Kinderen vanaf 3 jaar en jonger dan 8 jaar mogen het apparaat niet aansluiten, instellen of schoonmaken, of onderhoud uitvoeren.
- **LET OP — Sommige delen van dit apparaat kunnen zeer heet worden en brandwonden veroorzaken. Let vooral op wanneer kinderen en kwetsbare personen aanwezig zijn.**
- Controleer of de netvoeding overeenkomt met de gegevens op het typeplaatje. 230-240V~, 50Hz.
- Dit verwarmingstoestel is spat waterbestendig (IPX4) en kan daar-om in badkamers of andere vochtige ruimtes worden gebruikt, MITS HET

NIET IN DE ZONE VAN BADKUIPEN OF DOUCHES WORDT GEÏNSTALLEERD. Dit betekent dat het toestel niet in de zone aangeduid als VOLUME 1 (afbeelding 2) mag worden geïnstalleerd.

- Als u het apparaat inschakelt, moet het op een veilige plek zijn gemonteerd:
 - op minstens 1 m van ontvlambare objecten of meubilair;
 - 1 m vóór het apparaat mogen zich geen objecten bevinden;
 - niet direct onder een stopcontact.
- Laat dieren of kinderen niet met het apparaat spelen; ze mogen het bovendien niet aanraken. Let op! Het luchtuitlaatrooster kan erg warm worden als het apparaat in werking is ($> 90\text{ }^{\circ}\text{C}$).
- Gebruik het apparaat niet in ruimtes met explosieve gassen of terwijl u ontvlambare oplosmiddelen, lak of lijm gebruikt.
- Indien het netsnoer beschadigd is en vervangen moet worden, mag u dit niet zelf doen! Breng het apparaat naar een bevoegd reparatiecentrum of een persoon met vergelijkbare kennis en vaardigheden. Zo voorkomt u gevaarlijke situaties.
- Het apparaat moet zodanig worden gemonteerd dat het stopcontact altijd bereikbaar is.
- Bevestig het apparaat niet op wanden van synthetisch materiaal.
- **WAARSCHUWING:** Gebruik dit apparaat niet in kleine ruimtes wanneer ze worden bewoond door personen die niet in staat zijn om de ruimte alleen te verlaten, tenzij er voor voortdurend toezicht wordt gezorgd.
- **WAARSCHUWING:** Om het risico op brand te verminderen, dient u textiel, gordijnen of ander brandbaar materiaal op een minimale afstand van 1 m van de luchtuitlaat te houden.
- **WAARSCHUWING:** Dit apparaat is alleen bedoeld voor het drogen van in water gewassen textiel.

2. HET PRODUCT

- Naast de door u gekozen radiator bevat het pakket het volgende (afbeelding 1):
 - N° 1 metalen beugel voor wandmontage (bevestigd aan de radiator);
 - N° 4 nylon muurplugs $8 \times 50\text{ mm}$;
 - N° 4 kruiskopschroeven $5 \times 60\text{ mm}$ voor bevestigen van muurbeugel;
 - N° 2 handdoekbeugels
 - N° 4 schroeven $3,9 \times 13\text{ mm}$ voor de montage van de handdoekbeugels
- Neem contact op met uw dealer als iets defect is of ontbreekt.

3. WANDMONTAGE

- Het verwarmingstoestel uitsluitend verticaal monteren.
- Dit toestel beschikt over een dubbel elektrisch isolatiecircuit (klasse II). Een aardverbinding is daarom niet nodig.
- Dit toestel moet correct en conform de in uw land geldende voorschriften worden geïnstalleerd.
- In vochtige ruimtes (bijv. badkamer of keuken) moet het stopcontact ten minste 25 cm boven de vloer worden geïnstalleerd.
- Als u een of allebei de handdoekbeugels op het product wilt monteren, gebruik dan voor de montage de in afbeelding 3 getoonde schroeven.
- Houd voor het monteren van het product altijd de minimumafstanden van de zijwanden, vloer, plafond, meubelen of andere voorwerpen aan, zoals aangegeven in afbeelding 4. Monteer het product nooit op een afstand van minder dan 30 cm van de grond. Voor wandmontage:
 - Verwijder de wandsteunbeugel van het product door de twee veren aan de onderkant van de beugel los te maken.
 - gebruik de beugel als referentiepunt, door hem correct uit te lijnen met de haken bovenaan en de veren onderaan; markeer met een potlood op de wand de punten waar de pluggen en bevestigingsschroeven moeten worden aangebracht;
 - boor gaten in de wand op de 4 gemarkeerde punten en breng de 4 pluggen aan;
 - bevestig de wandbeugel met de 4 meegeleverde schroeven (afbeelding 6);
 - haak de radiator aan de bovenkant van de wandbeugel en klik vervolgens de twee veren aan de onderkant van de beugel vast (afbeelding 7);
 - Als u de radiator van de wand moet verwijderen, adviseren wij eerst de twee veren aan de onderkant van de beugel los te maken en het product vervolgens omhoog te tillen en het van de bovenste haken los te maken.

• HANDDOEKEN

- Verdeel de handdoeken altijd gelijkmatig over het oppervlak van de stangen (afbeelding 8-A).
- Leg nooit handdoeken of kledingstukken op de bovenkant van de radiator (afbeelding 8-B).
- Laat de handdoeken nooit meerdere lagen overlappen en klem ze vooral nooit tussen de stang en het oppervlak aan de voorkant van de radiator (afbeelding 8-C).

5. BESCHRIJVING BEDIENING EN GEBRUIK

- De volgende bedieningselementen zijn beschikbaar op het voorpaneel (afbeelding 9):
 - A - Stand-by
 - B - Temperatuur verhogen
 - C - Temperatuur verlagen
 - D - Modus
 - E - Display

Het product kan in 3 verschillende modi worden gebruikt: automatisch, geprogrammeerd of antivries:

Automatische modus

In deze modus werkt het product om de door de gebruiker ingestelde comforttemperatuur te bereiken en te handhaven. Een automatisch energiebeheersysteem zorgt voor een optimale regeling van het verbruik en een precieze aanpassing van het comfortniveau, waardoor de geselecteerde temperatuur constant blijft in de loop van de tijd, in overeenstemming met wat is ingesteld op de elektronische thermostaat. In de automatische modus is tevens een speciale functie beschikbaar, die door de gebruiker geactiveerd kan worden. Deze functie detecteert of een raam openstaat en schakelt het apparaat automatisch naar de vorstvrije modus om energieverspilling te beperken.

Weekprogramma modus

Het apparaat kan op uurbasis worden geprogrammeerd, voor elke dag van de week. Voor elk uur van de dag kan de keuzetemperatuur worden ingesteld die moet worden bereikt/gehandhaafd. U heeft daarbij keuze uit de temperaturen, COMFORT, ECO (waarvan de waarde gelijk is aan de verlaagde Comfort-temperatuur van 3,5 °C) of VORSTVRIJ.



In de weekprogramma modus is de openraamdetectie uitgeschakeld, zodat het apparaat het door de gebruiker ingestelde temperatuurprofiel correct kan volgen.

Vorstvrij modus

In deze modus wordt de thermostaat automatisch ingesteld op 7°C.

6. DE radiator GEBRUIKEN

STAND-BY TOETS

Gebruik de stand-by toets  om het product in te schakelen of in stand-by te zetten. Wanneer het product in stand-by staat, verschijnen er twee witte streepjes op het display:

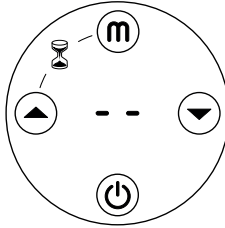

Wanneer het product is ingeschakeld, wordt het geactiveerd in de automatische modus. Het bericht "AU" wordt gedurende 3 seconden op het display weergegeven en daarna wordt de ingestelde temperatuur weergegeven:

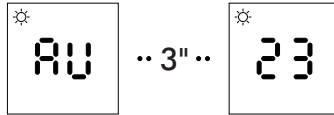



BEDRIJFS MODI

Als u op toets  drukt, is het mogelijk om de automatische, geprogrammeerde of vorstvrije modus te selecteren zoals beschreven in paragraaf 5:

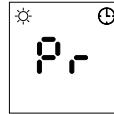

Druk op de  toets om over te schakelen van de automatische naar de programmamodus. Het display toont "Pr". Het kloksymbool en het pictogram met betrekking tot de modus die is ingesteld voor de huidige tijd en dag (comfort, eco of antivries) lichten ook op het display.



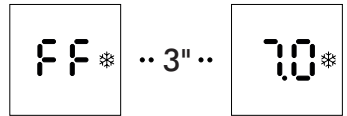

Druk op de  toets om van de geprogrammeerde naar de vorstvrije modus te gaan. Op het display verschijnt 3 seconden "FF" en vervolgens wordt de verwachte temperatuur van 7,0 °C (niet instelbaar) en het symbool voor de antivriesmodus op het display verlicht.





Druk nogmaals op de  toets om terug te keren naar de automatische modus en de cyclus opnieuw te starten.

INSTELLINGEN

Met de toetsen ,  en  kunt u de huidige tijd en dag, de comforttemperatuur instellen en de detectie van het openen van een raam activeren of deactiveren. Dag "1" komt overeen met MAANDAG.



Houd de  toets minimaal 3 seconden ingedrukt om de instellingen vanaf de tijd te bekijken/wijzigen.

Stel het huidige uur in met de  en  toetsen.





Druk op de **M** toets om naar de instelling van de minuten te gaan.

Stel de huidige minuten in met de en toetsen.

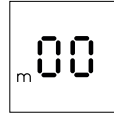

...

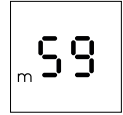

Druk op de **M** toets om naar de instelling van de dag te gaan.

Stel huidige dag van de week in met de en toetsen (1 = maandag).

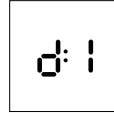

...



Druk op de **M** toets om over te schakelen naar de instelling voor detectie van open ramen.

Zet de functie AAN of UIT met de en toetsen.

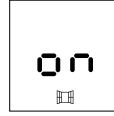

...



Druk op de **M** toets om de instellingen te verlaten en de normale werking te hervatten.

OPEN RAAM DETECTIE

Deze functie maakt het mogelijk een grote temperatuurdaling te detecteren en automatisch de bedrijfsmodus Antivries te activeren. Wanneer de functie is ingeschakeld en gereed is om de Vorstvrij-modus in te stellen wanneer dit wordt gedetecteerd, is een vensterpictogram zichtbaar op het onderste gedeelte van het display.

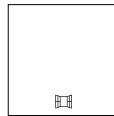



Als tijdens de normale werking een snelle temperatuurdaling in de ruimte wordt waargenomen, wordt automatisch de Vorstvrij-modus geactiveerd om energieverbruik te besparen. Het display geeft de antivriestemperatuur weer en het vensterpictogram knippert om aan te geven dat de functie raam openen actief is.



Het resetten van de normale werking is niet automatisch maar wordt bereikt door op een van de toetsen van het product te drukken. De juiste werking van deze functie kan afhangen van de plaats van de radiator in de ruimte, de aanwezigheid van tocht, de buitentemperatuur en hoe lang de temperatuurdaling aanhoudt.

DISPLAY / COMFORTTEMPERATUUR WIJZIGEN

De comforttemperatuur wordt weergegeven in de automatische modus en kan worden gewijzigd door op de  of  toets te drukken. De Eco-temperatuur, gebruikt in de geprogrammeerde modus, kan niet worden gewijzigd en is altijd gelijk aan de Comfort-temperatuur -3,5 °C. De antivriestemperatuur is ook vast en gelijk aan 7°C.

Opmerking: de temperatuur gemeten door de binnensensor van het product is representatief voor de omgevingstemperatuur in de buurt en kan verschillen van de temperatuur gemeten met andere instrumenten in andere delen van de kamer. Dat verschil kan van veel factoren afhangen, waaronder bijvoorbeeld:

- de installatiepositie: sommige delen van de kamer kunnen worden beïnvloed door tocht of heteluchtzakken die de sensor-meting wijzigen;
- de bevestiging aan een buitenmuur, die normaal gesproken kouder zijn dan binnenmuren, kan betekenen dat een temperatuur wordt gemeten die lager is dan de werkelijke kamertemperatuur;
- onstabiele omstandigheden: elke evaluatie moet gebeuren in stabiele werkomstandigheden. Hiervoor dient de comforttemperatuur pas 120 minuten na een eerdere wijziging te worden gewijzigd. Het is niet mogelijk om de kamertemperatuur die door het product wordt gehandhaafd correct te evalueren als de temperatuur van het comfortniveau in korte tijd voortdurend wordt gewijzigd.



Als er een verschil tussen de ingestelde temperatuur en de kamertemperatuur wordt gedetecteerd in stabiele werkomstandigheden, is het mogelijk om de meting van de elektronische thermostaat van het product aan te passen. Deze handeling is ook bijzonder nuttig wanneer de heater zeer dicht bij de vloer of het plafond wordt geïnstalleerd.

Ga als volgt te werk om deze correctie in te stellen:

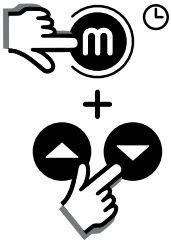
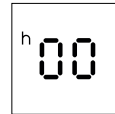

Houd de  toets ingedrukt: het display toont de huidige tijd.



Houd de  toets ingedrukt en druk tegelijkertijd op de toetsen  en . Het display toont gedurende 2 seconden "AL" (Alignment) en vervolgens de werkelijke uittijningswaarde (de standaardwaarde is 0).

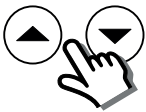
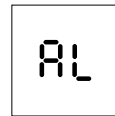

Gebruik de  en  toetsen om de gewenste correctie in te stellen door een waarde tussen -5 en +5 te kiezen.

Correctievoorbeeld:

Als het product is ingesteld op 19°C maar in de kamer 20°C wordt gemeten in stabiele omstandigheden, is de in te brengen correctie gelijk aan $20 - 19 = 1$; Als daarentegen het product is ingesteld op 19°C maar in de ruimte bijvoorbeeld 17°C wordt gemeten, is de in te stellen uitlijning gelijk aan $17 - 19 = -2$.

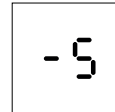

...

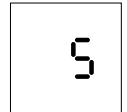

Druk op de  om de correctie modus te verlaten en de normale werking te hervatten.

WEEK PROGRAMMA

De geprogrammeerde modus maakt het mogelijk om voor elk uur van de dag en voor elke dag van de week onafhankelijk de gewenste temperatuur in te stellen, te kiezen tussen Comfort, Eco (gelijk aan die van Comfort verlaagd met 3,5°C) of Vorstvrij.

Om de geprogrammeerde modus te activeren, drukt u op de  toets totdat het display "Pr" toont.

De fabrieksinstellingen zijn als volgt:

Vorstvrije modus behalve Comfortmodus in de volgende uren:

- maandag t/m vrijdag van 06:00 tot 08:00 uur;
- van 08:00 tot 10:00 uur op zaterdag-zondag.

In de geprogrammeerde modus kunt u het programma weergeven/

wijzigen door de toetsen  en  tegelijk in te drukken. Het display toont dag 1 (maandag).

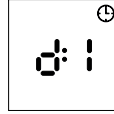

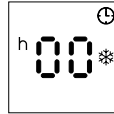

Door op de toetsen  en  te drukken, worden de verschillende uren van de dag weergegeven vanaf "00" (tijd tussen 00:00 en 00:59).

De ingestelde referentietemperatuur voor de geselecteerde tijd wordt aangegeven door het inschakelen van het antivriespictogram (temperatuur van 7 ° C), het Eco-pictogram (Eco-temperatuur = Comfort - 3,5 ° C) of het Comfort-pictogram (comforttemperatuur ingesteld door de gebruiker).

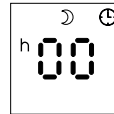
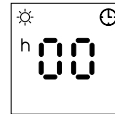
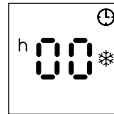

De gewenste temperatuur kan worden gewijzigd door op de  toets te drukken. De verlichting in volgorde van de hierboven beschreven pictogrammen geeft de referentietemperatuur aan.



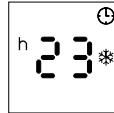

Gebruik de  en  toetsen om de ingestelde temperatuur voor elk van de uren van dag 1 van 00 tot 23 te bekijken/wijzigen.



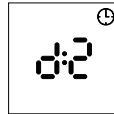

Door om 23:00 uur (23) opnieuw op de  toets te drukken, krijgt u toegang tot de programmering voor dag 2.

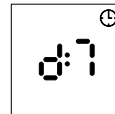
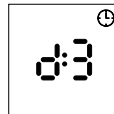

Nu is het mogelijk om te kiezen of u de temperatuur van de afzonderlijke uren van dag 2 wilt weergeven/wijzigen of dat u dag 2 identiek aan dag 1 wilt instellen.

1. Gebruik in het eerste geval de  en  toetsen en zoals reeds beschreven voor dag 1, in het tweede geval drukt u gewoon op weer de  toets. Hierdoor wordt dag 2 automatisch gelijkgesteld aan dag 1 en gaat het systeem naar het begin van dag 3. Deze procedure kan herhaald worden tot de programmering voor dag 7.





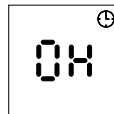

Aan het einde van de programmering op dag 7, of in een tussenvolgende fase van de programmering, na het indrukken van de  toets, komt u in de fase van het opslaan van het programma. Het bericht "OK" verschijnt op het display en het zojuist gedefinieerde programma is opgeslagen.



- Het is op elk moment mogelijk om de weergave-/aanpassingsprocedure te verlaten door de nog niet opgeslagen wijzigingen te verwijderen door 30 seconden te wachten zonder een toets aan te raken;
- Tijdens het programmeren zijn de verwarmingselementen uitgeschakeld en wordt het product niet warm.

BOOST FUNCTIE

De BOOST-functie maakt een getimede werking van de radiator mogelijk gedurende de gewenste tijd en zonder regeling van de kamertemperatuur. Wanneer de geselecteerde tijd verstreken is, keert de radiator terug naar de modus die is ingesteld voordat de timer werd geactiveerd.

Om de timerfunctie te activeren, drukt u tegelijkertijd op de toetsen  en . De vooraf ingestelde tijd van de timer is 60' en knippert enkele seconden op het display. Tijdens deze fase kan de tijdsduur worden gewijzigd tussen 60, 90 of 120 minuten (2u) met de toetsen  e . Na 5 seconden stopt de tijdsduur op het display met knipperen en is de tijd ingesteld. Vanaf nu toont het display de resterende tijdsduur.

Indien de resterende tijd tussen 1 uur en 2 uur ligt, worden de resterende minuten (1 t/m 59) getoond en vervolgens het cijfer 1h , gedurende 3 seconden. Als de resterende tijd minder dan 1 uur is, worden alleen de resterende minuten (1 t/m 59) getoond.

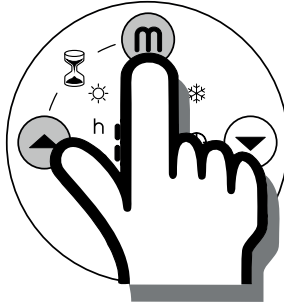

7. PROBLEEMOPLOSSING

- In geval van oververhitting schakelt de veiligheidsvoorziening van het apparaat de verwarmingselementen automatisch uit. In dat geval moet u het volgende doen:
 - Schakel de heater uit en laat deze gedurende circa 15/20 minuten afkoelen.
 - Controleer of er andere oorzaken van oververhitting zijn (bijv. objecten die zich voor het luchtinlaat-/uitlaatrooster bevinden, vuilophoping).
 - Zet de heater weer aan en controleer of deze correct functioneert.
- Indien de toetsen geblokkeerd zijn of niet juist reageren als erop gedrukt wordt, moet u het apparaat spanningsloos maken. Schakel de verwarming vervolgens weer in.

8. ONDERHOUD

- Dit apparaat vereist geen specifiek onderhoud.
- Maak het apparaat om de zes maanden met een droge doek schoon.
- Indien het apparaat gerepareerd dient te worden, dient u contact op te nemen met een erkend technisch servicecentrum.
- Als het netsnoer vervangen moet worden, dient een 2 x 1,00 mm²-kabel (type H05V2V2-F HAR) te worden gebruikt. Dit mag uitsluitend door gekwalificeerd personeel en nooit door de eindgebruiker zelf worden gedaan om schade aan het apparaat en/of persoonlijk letsel te voorkomen.

9. JURIDISCHE MEDEDELING



Milieu en recycling

Help ons mee het milieu te beschermen. Verwijder de verpakking daarom overeenkomstig de nationale voorschriften voor afvalverwerking.

Recycling van oude toestellen

Toestellen met dit symbool horen niet thuis in de vuilnisbak. Ze moeten apart worden ingezameld en volgens lokale voorschriften worden verwijderd.

Informatie-eisen voor elektrische toestellen voor lokale ruimteverwarming

Typeaanduiding(en): ONSEN					
Item	Symbol	Waarde	Eenheid	Item	Eenheid
Warmteafgifte				Type warmte-input, uitsluitend voor elektrische warmteopslagtoestellen (selecteer één)	
Nominale warmteafgifte	P_{nom}	0,75	kW	Handmatige sturing van de warmteopslag, met geïntegreerde thermostaat	neen
Minimale warmteafgifte (indicatief)	P_{min}	0,75	kW	Handmatige sturing van de warmteopslag, met kamer- en/of buitentemperatuurfeedback	neen
Maximale continue warmteafgifte	$P_{max,c}$	0,75	kW	Elektronische sturing van de warmteopslag, met kamer- en/of buitentemperatuurfeedback	neen
Aanvullend elektriciteitsverbruik				Door een ventilator bijgestane warmteafgifte	neen
Bij nominale warmteafgifte	$e_{l,max}$	0,000	kW	Type warmteafgifte/sturing kamertemperatuur (selecteer één)	
Bij minimale warmteafgifte	$e_{l,min}$	0,000	kW	Eentrapswarmteafgifte, geen sturing van de kamertemperatuur	neen
In stand-bymodus	$e_{l,SB}$	0,343	W	Twee of meer handmatig in te stellen trappen, geen sturing van de kamertemperatuur	neen
				Met mechanische sturing van de kamertemperatuur door thermostaat	neen
				Met elektronische sturing van de kamertemperatuur	neen
				Elektronische sturing van de kamertemperatuur plus dag-tijdschakelaar	neen
				Elektronische sturing van de kamertemperatuur plus week-tijdschakelaar	ja
				Andere sturingsopties (meerdere selecties mogelijk)	
				Sturing van de kamertemperatuur, met aanwezigheidsdetectie	neen
				Sturing van de kamertemperatuur, met openraamdetectie	ja
				Met de optie van afstandsbediening	neen
				Met adaptieve sturing van de start	neen
				Met beperking van de werkingstijd	neen
				Met black-bulbsensor	neen
Contactgegevens	Ermete Giudici S.p.A. - via L. da Vinci, 27 - 20090 Segrate (MI) Italien				

Technische referentiewaarden bij een voedingsspanning van 230V 50Hz

Before operating the heater, please read these instructions thoroughly to avoid damage and hazardous situations. Any use of this heater other than that stipulated in this instruction manual may cause fire, electric shock or injury, and voids all warranties.

Warranty does not apply to any defect, deterioration, loss, injury or damage caused by, or as a result of, the misuse or abuse of this heater. The rights dictated by State law are not prejudiced. None of the terms of this warranty are to be taken as excluding any conditions or warranties implied by State law, which cannot be excluded or modified.

Before any operation remove the packaging and check product integrity. In case of defects or damages do not try to repair it yourself but contact your dealer.

Do not let children play with the packaging and protect the environment by disposing of the packaging in accordance with the national regulations for waste processing.

1. FOR YOUR SAFETY

- This appliance is intended for normal household use and not for use in vehicles or on board ships or aircrafts.
- This appliance can be used by children aged from 8 years and above and persons with reduced physical, sensory or mental capabilities or lack of experience and knowledge if they have been given supervision or instruction concerning use of the appliance in a safe way and understand the hazards involved. Children shall not play with the appliance. Cleaning and user maintenance shall not be made by children without supervision.
- Children of less than 3 years should be kept away unless continuously supervised.
- Children aged from 3 years and less than 8 years shall only switch on/off the appliance provided that it has been placed or installed in its intended normal operating position and they have been given supervision or instruction concerning use of the appliance in a safe way and understand the hazards involved. Children aged from 3 years and less than 8 years shall not plug in, regulate and clean the appliance or perform user maintenance.
- **CAUTION — Some parts of this product can become very hot and cause burns. Particular attention has to be given where children and vulnerable people are present.**
- Make sure that your supply rating corresponds to what specified on the rating plate: 230-240V~, 50Hz.
- This heater is water resistant to IPX4. It can therefore be used in bathrooms or other areas subject to humidity AS LONG AS IT IS NOT

INSTALLED WITHIN THE PERIMETER OF BATH TUBS OR SHOWERS. This means that it cannot be installed in the areas marked as VOLUME 1 in picture 2.

- During function, place the heater in a safe position:
 - at least 1m far from inflammable objects or furnitures;
 - leaving not less than 1m of free space in front of the heater;
 - not located immediately below a socket-outlet.
- Do not leave animals or children touch or play with the appliance. Pay attention! The air outlet grille gets hot during operation (more than 90°C)
- Do not use the heater in rooms with explosive gas or while using inflammable solvents or varnish or glues.
- If the cordset is damaged and you have to change it, do not do the job yourselves! Take the product to an after sales authorised repair centre or to a person with similar skill and knowledge, in order to avoid any risk of danger.
- The appliance must be positioned so that the plug is always accessible.
- Do not mount the product on walls made of synthetic material.
- **WARNING:** Do not use this heater in small rooms when they are occupied by persons not capable of leaving the room on their own, unless constant supervision is provided.
- **WARNING:** To reduce the risk of fire, keep textiles, curtains, or any other flammable material a minimum distance of 1 m from the air outlet.
- **WARNING:** This appliance is intended only for drying textiles washed in water.

2. YOUR PRODUCT

- Other than the heater you have chosen the package includes (picture 1):
 - N° 1 metal brackets for wall mounting (fixed to the radiator);
 - N° 4 nylon plug expansion 8x50mm;
 - N° 4 5x60mm cross head screws to fix wall brackets;
 - N° 2 bars for towels;
 - N° 4 3,9x13mm screws to fix the bars to the heater.
- Refer to your dealer if something is broken or missing.

3. WALL MOUNTING

- Only fix the heater in vertical position;
- This heater is fitted with a double electrical insulation circuit (class II) and therefore does not require an earth connection.
- This heater must be correctly installed in compliance with the regulations in force in the country of installation.
- In wet spaces like bathrooms or kitchens, the connection terminal must be installed at least 25 cm above the floor. The electrical connection to the power supply must also be fitted with a two-pole switch with a minimum gap between the contacts that allows complete disconnection according to excess voltage III category conditions.
- If you want to fix one or both towel rails to the product, before fixing the appliance to the wall bracket use the supplied screws as illustrated in picture 3.
- Always make observe the minimum distances from walls, furniture and/or objects, as indicated in picture 4. Never install the product so that the distance between the floor and the lower side of the product is less than 30cm:
 - Remove the wall-mounting bracket fixed to the back of the radiator, by releasing the 2 lower springs;
 - Use a pencil to mark the position of the fixing points (picture 5).
 - Drill the 4 holes at the points marked previously, and insert the plastic anchors;
 - Fix the bracket to the wall using the 4 screws supplied (picture 6);
 - Hook the radiator to the bracket starting with the 2 upper fixing points, and then click the 2 lower fixing points into position (picture 7);
 - Should you have to remove the radiator from the bracket at a later stage, we recommend releasing the lower two fixing points first and then the upper fixings.

4. TOWELS

- Always outspread the towels over the support bars (picture 8-A);
- Do not place the towels on top of the product (picture 8-B);
- Do not roll up the towels between the bar and the front surface (picture 8-C).

5. COMMAND DESCRIPTION AND FUNCTIONING

- The following controls are available on the front panel (picture 9):
 - A - Stand-by
 - B - Increase
 - C - Decrease
 - D - Mode
 - E - Display

The product can be operated in 3 different modes: automatic, programmed or frost free.

Automatic Mode

In this mode the product works to reach and maintain the Comfort temperature set by the user. An automatic power management system allows optimum control of consumption and precise adjustment of the comfort level automatically maintaining the selected temperature constant over time, in accordance with what has been set on the electronic thermostat.

In automatic mode is also available a special feature, which is activated at user's choice, which allows to detect the possible opening of a window and force the functioning to the Frost free mode to minimize energy waste.

Programmed Mode

The product can be programmed, on hour base, for each day of the week. For each hour of the day it is possible to define the reference temperature to be reached/maintained, choosing between Comfort, Eco (whose value is equal to the Comfort temperature reduced by 3,5°C) or Frost free.

 In programmed mode the open window detection function is disabled so that the product can correctly follow the temperature profile defined by the user.

Frost free Mode

In this mode the thermostat is automatically set to maintain $7\pm 3^{\circ}\text{C}$.

6. USING THE HEATER

STAND-BY BUTTON

Use the  button to turn on or put the product in Stand-by. When the product is in Stand-by, two white dashes appear on the display:

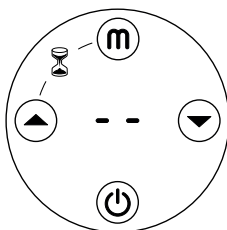

When the product is turned on, it activates in Automatic mode. The message "AU" is shown for 3 seconds on the display and, after, the set temperature is shown:

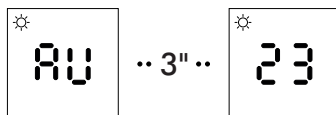

OPERATING MODES

By pressing the  button it is possible to select Automatic, Programmed or Frost free mode as described in paragraph 5:



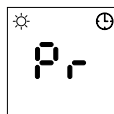

Press the  key to switch from automatic to programmed mode. The display shows "Pr".

The clock symbol and the icon relating to the operating mode set for the current time and day (comfort, eco or antifreeze) also light up on the display.



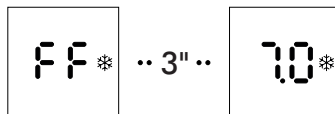

Press the  key to switch from programmed to frost free mode. The display shows "FF" for 3 seconds and then the expected temperature of 7.0°C (not modifiable) and the antifreeze mode symbol also lights up on the display.





Press the  button again to return to automatic mode and restart the cycle.

SETTINGS

The buttons ,  and  allow you to set the current time and day, the Comfort temperature and to activate or deactivate the detection of the opening of a window. Day "1" corresponds to MONDAY.





Press the  button for at least 3 seconds to view/change the settings starting from the time.

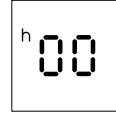

Set the current hour using  and  buttons.

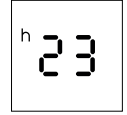

...



Press the  button to switch to the setting of the minutes.

Set the current minutes using  and  buttons.



...



Press the  button to switch to the setting of the day.

Set the current day of the week using  and  buttons (1 = Monday).

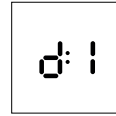

...



Press the  button to switch to the open window detection setting.

Set the function ON or OFF using  and  buttons.

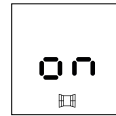

...



Press the  button to exit the settings and resume the normal functioning.

OPEN WINDOW DETECTION

This function makes it possible to detect an open window and automatically activate the Anti-freeze operating mode. When the function is enabled and ready to set the Frost-free mode if an open windows is detected, a window icon is visible on the lower area of the display.

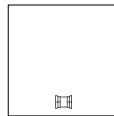

If a temperature drop is observed in the room during the normal functioning, the Frost-free mode is automatically activated to save energy consumption. The display shows the antifreeze temperature and the window icon flashes to show that the open window function operates.





The reset of the normal functioning is not automatic but is achieved by pressing one of the buttons of the product.



Correct operation of this function may depend on where the radiator is positioned in the room, the presence of draughts, the outside temperature, and how long the window stays open.

DISPLAY / CHANGE THE COMFORT TEMPERATURE

The Comfort temperature is shown in the Automatic mode and can be changed by pressing the  or  key.

The Eco temperature, used in programmed mode, cannot be changed and is always the same as the Comfort temperature -3.5°C. The Antifreeze temperature is also fixed and equal to 7°C.

Note: The temperature measured by the inner sensor of the product is representative of the ambient temperature nearby it and it may differ from the temperature measured using other instruments in other areas of the room. That difference may depend on many factors including, for example:

- the installation position: some areas of the room may be affected by drafts or hot air sacs that modify the sensor measurement;
- the fixation to an external wall that, being normally colder than internal walls, may imply the measurement of a temperature lower than the real room temperature;
- unstable conditions: any evaluation must be done in stable working conditions. For this purpose comfort temperature should be changed only 120min after a previous change . It is not possible, indeed, to evaluate the room temperature maintained by the product correctly if the comfort level temperature is continually changed in a short time.



If a difference between set temperature and room temperature is detected in stable working conditions, it is possible to adjust the measurement made by the electronic thermostat of the product. This operation is also particularly useful when installing the heater very close to the floor or ceiling.

To set this correction proceed as follows:



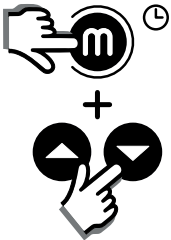
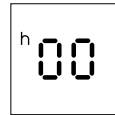

Press and HOLD the  key: the display will show the current time.

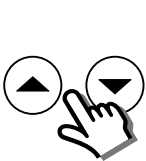
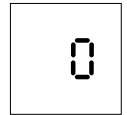

While continuing to hold down the  key, press the  and  keys at the same time. The display shows "AL" (alignment) for 2 seconds and then the actual alignment value (the default value is 0).



Use the  and  keys to set the desired alignment by choosing a value between -5 and +5. Alignment example:
If the product has been set at 19°C but in the room 20°C is measured in stable conditions, the alignment to be inserted is equal to $20-19 = 1$;
If, on the other hand, the product is set at 19°C but in the room, for example, 17°C is measured, the alignment to be set is equal to $17-19 = -2$.

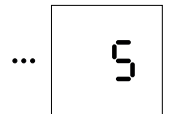
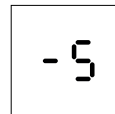

Press the  button to exit the alignment and resume the normal functioning.

WEEKLY PROGRAM



The Programmed mode allows to set, for every hour of day and for every day of the week independently, the desired temperature choosing between the Comfort, Eco (equal to that of Comfort decreased by 3.5°C) or Frost-free.

To activate the Programmed mode, press the  key until the display shows "P". If the product is brand new the default program is the following:



Always Frost-free mode except Comfort mode in the following hours:

- from 06:00 to 08:00 on Monday-Friday;
- from 08:00 to 10:00 on Saturday-Sunday.

When in Programmed mode you can display/modify the program

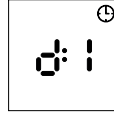
by pressing the  and  keys together. The display shows day 1 (Monday).



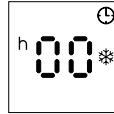

By pressing the  and  keys, the different hours of the day are displayed starting from "00" (time between 00:00 and 00:59). The reference temperature set for the selected time is indicated by turning on the antifreeze icon (temperature of 7 °C), the Eco icon (Eco temperature = Comfort - 3.5 °C) or the Comfort one (Comfort temperature set by the user).

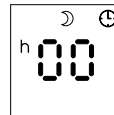
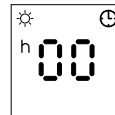
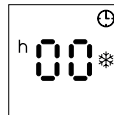

The desired temperature can be changed by pressing the  key. The lighting in sequence of the icons described above indicates the reference temperature.



Use the  and  keys to view/modify the temperature set for each of the hours of day 1, from 00 to 23.

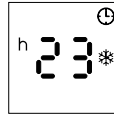

At 11 pm (23), pressing the  key again allows access to the programming for day 2.

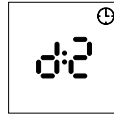

Now it is possible to choose whether to display/modify the temperature of the single hours of day 2 or set day 2 identical to day

1. In the first case, use the  and  keys as already descri-

bed for day 1, in the second just press again the button . By doing so, day 2 is automatically set equal to day 1 and the system moves to the beginning of day 3. This procedure can be repeated until programming for day 7.

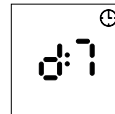
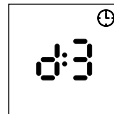

At the end of the programming on day 7, or in any intermediate phase of the programming, after pressing the  key, you access the program saving phase. The message "OK" appears on the display and the program just defined is stored.

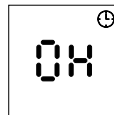





Note:



- At any time it is possible to abandon the viewing/modification procedure by deleting the modifications not yet saved by waiting 30 seconds without touching any key;
- During the programming the heating elements are disconnected and the product doesn't heat.

BOOST FUNCTION

The Boost function allows you to activate timed operation at maximum power without the thermostat control. At the end of this forced operation, the heater returns to the operating mode prior to activation.

To activate the function press and at the same time the buttons  and . The default duration of 60min flashes on the display. The duration can be chosen between the values of 60, 90 or 120 minutes (2h) using the buttons  and . 5 seconds after the last selection the function is activated.

If the remaining time is less than or equal to 59min the display shows the remaining minutes of heating. If higher the display shows the remaining minutes preceded by the word "1h" shown for 3 seconds.

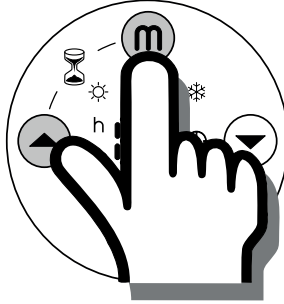

7. TROUBLESHOOTING

- In the event of overheating, the safety device on the appliance automatically disabled the heating element. In this case:
 - Turn off the radiator and allow it to cool down for about 15/20 minutes.
 - Eliminate any other possible reasons for overheating (e.g.: obstructions in front of the air inlet/outlet grilles, build-ups of dirt).
 - Turn on the radiator and check it works correctly.
- If the touch control commands are blocked or don't properly answer to digital pressure, turn off the heater for 1min and then try again.

8. MAINTENANCE

- This product does not require any special maintenance.
- Clean the product with a dry cloth once every 6 months.
- If the product requires repairing, contact an authorised technical service centre.
- When replacing the power cable, use a 2x1,00mm² H05V2V2-F HAR type. This operation must be performed by qualified personnel and never by the end user in order to avoid damaging the appliance and jeopardising personal safety.

9. LEGAL NOTICE



Environment and recycling

Please help us to protect the environment by disposing of the packaging in accordance with the national regulations for waste processing.

Recycling of obsolete appliances

Appliances with this label must not be disposed off with the general waste. They must be collected separately and disposed off according to local regulations.

Information requirements for electric local space heaters

Model identifier(s): ONSEN					
Item	Symbol	Value	Unit	Item	Unit
Heat output				Type of heat input, for electric storage local space heaters only (select one)	
Nominal heat output	P_{nom}	0,75	kW	manual heat charge control, with integrated thermostat	no
Minimum heat output (indicative)	P_{min}	0,75	kW	manual heat charge control with room and/or outdoor temperature feedback	no
Maximum continuous heat output	$P_{max,c}$	0,75	kW	electronic heat charge control with room and/or outdoor temperature feedback	no
Auxiliary electricity consumption				fan assisted heat output	no
At nominal heat output	$e_{l_{max}}$	0,000	kW	Type of heat output/room temperature control (select one)	
At minimum heat output	$e_{l_{min}}$	0,000	kW	single stage heat output and no room temperature control	no
In standby mode	$e_{l_{SB}}$	0,343	W	Two or more manual stages, no room temperature control	no
				with mechanic thermostat room temperature control	no
				with electronic room temperature control	no
				electronic room temperature control plus day timer	no
				electronic room temperature control plus week timer	yes
				Other control options (multiple selections possible)	
				room temperature control, with presence detection	no
				room temperature control, with open window detection	yes
				with distance control option	no
				with adaptive start control	no
				with working time limitation	no
				with black bulb sensor	no
Contact details:	Ermete Giudici S.p.A. - via L. da Vinci, 27 - 20090 Segrate (MI) Italy				

Reference values at 230V 50Hz

Bitte lesen Sie diese Anleitung vor Inbetriebnahme des Heizgerätes sorgfältig durch, um Schäden und Gefahrensituationen zu vermeiden. Jegliche Verwendung dieses Heizgeräts, die nicht in dieser Bedienungsanleitung angegeben ist, kann zu Bränden, Stromschlägen oder Verletzungen führen und führt zum Erlöschen aller Garantien.

Die Garantie gilt nicht für Defekte, Verschlechterungen, Verluste, Verletzungen oder Schäden, die durch oder als Folge des Missbrauchs oder Fehlnutzung dieses Heizgeräts verursacht werden. Die durch staatliches Recht vorgeschriebenen Rechte werden nicht beeinträchtigt. Keine der Bedingungen dieser Garantie ist so zu verstehen, dass sie Bedingungen oder Garantien ausschließt, die durch staatliche Gesetze impliziert sind, die nicht ausgeschlossen oder geändert werden können.

Entfernen Sie vor jedem Eingriff die Verpackung und überprüfen Sie die Unversehrtheit des Produkts. Versuchen Sie bei Defekten oder Beschädigungen nicht, es selbst zu reparieren, sondern wenden Sie sich an Ihren Händler.

Lassen Sie Kinder nicht mit der Verpackung spielen und schonen Sie die Umwelt, indem Sie die Verpackung gemäß den nationalen Vorschriften zur Abfallbehandlung entsorgen.

1. FÜR IHRE SICHERHEIT

- Dieses Gerät ist für den normalen Hausgebrauch bestimmt und nicht für den Gebrauch in Fahrzeugen oder an Bord von Schiffen oder Flugzeugen.
- Dieses Gerät kann von Kindern ab 8 Jahren verwendet werden und Personen mit eingeschränkten körperlichen, sensorischen oder geistigen Fähigkeiten oder Mangel an Erfahrung und Wissen, wenn sie beaufsichtigt oder bezüglich des sicheren Gebrauchs des Geräts unterwiesen wurden und die damit verbundenen Gefahren verstehen. Kinder dürfen nicht mit dem Gerät spielen. Reinigung und Benutzerwartung dürfen nicht von Kindern ohne Aufsicht durchgeführt werden.
- Kinder unter 3 Jahren sollten ferngehalten werden, es sei denn, sie werden ständig beaufsichtigt.
- Kinder im Alter von 3 Jahren und unter 8 Jahren dürfen das Gerät nur ein-/ausschalten, wenn es in seiner vorgesehenen normalen Betriebsposition aufgestellt oder installiert wurde und sie beaufsichtigt oder bezüglich der Verwendung des Geräts in einer sicheren Weise eingewiesen wurden und die damit verbundenen Gefahren verstehen. Kinder im Alter von 3 Jahren und unter 8 Jahren dürfen das Gerät nicht anschließen, regulieren und reinigen oder Benutzerwartungen durchführen.
- **VORSICHT — Einige Teile dieses Produkts können sehr heiß werden und Verbrennungen verursachen. Wo Kinder und schutzbedürftige Personen anwesend sind, muss besondere Aufmerksamkeit geschenkt werden.**
- Stellen Sie sicher, dass Ihre Versorgungsspannung mit der Angabe

- auf dem Typenschild übereinstimmt: 230-240V~, 50Hz.
- Diese Heizung ist wasserdicht nach IPX4. Es kann daher in Badezimmern oder anderen Feuchträumen verwendet werden, SOLANGE ES NICHT IM BEREICH VON BADEWANNEN ODER DUSCHEN INSTALLIERT WIRD. Dies bedeutet, dass es nicht in den Bereichen installiert werden kann, die in Bild 2 als VOLUME 1 gekennzeichnet sind.
 - Stellen Sie den Heizgerät während des Betriebs in eine sichere Position:
 - mindestens 1m Abstand zu brennbaren Gegenständen oder Möbeln;
 - vor dem Erhitzer mindestens 1m Freiraum lassen;
 - sich nicht unmittelbar unter einer Steckdose befinden.
 - Lassen Sie keine Tiere oder Kinder das Gerät berühren oder damit spielen. Passt auf! Das Luftauslassgitter wird während des Betriebs heiß;
 - Verwenden Sie das Heizgerät nicht in Räumen mit explosivem Gas oder während der Verwendung von brennbaren Lösungsmitteln oder Lacken oder Klebstoffen.
 - Wenn der Kabelsatz beschädigt ist und Sie ihn austauschen müssen, führen Sie die Arbeit nicht selbst durch! Bringen Sie das Produkt zu einem autorisierten Kundendienstzentrum oder zu einer Person mit ähnlichen Fähigkeiten und Kenntnissen, um jegliches Gefahrenrisiko zu vermeiden.
 - Das Gerät muss so aufgestellt werden, dass der Stecker immer zugänglich ist.
 - Montieren Sie das Produkt nicht an Wänden aus Kunststoff.
 - **WARNUNG:** Verwenden Sie dieses Heizgerät nicht in kleinen Räumen, in denen sich Personen aufhalten, die den Raum nicht alleine verlassen können, es sei denn, es wird eine ständige Beaufsichtigung gewährleistet.
 - **WARNUNG:** Um die Brandgefahr zu verringern, halten Sie Textilien, Vorhänge oder andere brennbare Materialien in einem Mindestabstand von 1 m vom Luftauslass.
 - **WARNUNG:** Dieses Gerät ist nur zum Trocknen von in Wasser gewaschenen Textilien bestimmt.

2. IHR GERÄT

- Neben dem von Ihnen gewählten Heizgerät enthält die Verpackung (Abbildung 1):
 - 1 x Metallaufhängung für Wandmontage (am Heizgerät angebracht)
 - 4 x Nylon-Dübel 8x50 mm
 - 4 x Kreuzschlitzschrauben 5x60 mm zur Befestigung der Wandaufhängung
 - 2 x Handtuchhalter
 - 4 x Schrauben 3,9 * 13 mm zur Befestigung der Handtuchhalter
- Bitte wenden Sie sich an Ihren Händler, falls ein Teil fehlt oder beschädigt ist.

3. WANDMONTAGE

- Befestigen Sie das Heizgerät nur in vertikaler Position.
- Dieses Heizgerät ist mit einem doppelten elektrischen Isolationskreis (Klasse II) ausgestattet und benötigt daher keinen Erdanschluss.
- Dieses Heizgerät muss gemäß den im Installationsland geltenden Vorschriften korrekt installiert werden.
- In Nassräumen wie Badezimmern oder Küchen muss die Anschlussklemme mindestens 25 cm über dem Boden installiert werden. Der elektrische Anschluss an die Stromversorgung muss ebenfalls mit einem zweipoligen Schalter mit einem Mindestabstand zwischen den Kontakten ausgestattet sein, der eine vollständige Trennung gemäß den Bedingungen der Überspannungskategorie III ermöglicht.
- Sollen einer oder beide Handtuchhalter am Produkt montiert werden, muss dies erfolgen, bevor das Produkt an der Wand montiert wird. Für die Montage die auf Abbildung 3 dargestellten Schrauben verwenden.
- Bei der Montage des Produkts müssen immer die Mindestabstände zu Seitenwänden, Boden, Decke, Möbeln oder anderen Gegenständen berücksichtigt werden, siehe Abbildung 4. Das Gerät niemals in einem Abstand von weniger als 30cm zum Boden installieren. Für die Montage an der Wand:
 - Die Wandhalterung vom Produkt entfernen, hierzu die beiden Federn an der Unterseite der Halterung aushaken.
 - Mit einem Bleistift an der Wand die Stellen markieren, an denen die Dübel und die Befestigungsschrauben eingesetzt werden sollen (Abbildung 5).
 - An den 4 markierten Stellen Löcher in die Wand bohren und die 4 Spreizdübel einsetzen.
 - Die Wandhalterung mit den 4 mitgelieferten Schrauben (Abbildung 6) befestigen.
 - Den Heizkörper in den oberen Teil der Wandhalterung einhängen und anschließend die beiden Federn am unteren Teil der Halterung einrasten lassen (Abbildung 7).
 - Wenn der Heizkörper von der Wand abgenommen werden muss, empfehlen wir, zuerst die beiden Federn an der Unterseite der Halterung zu lösen und dann das Produkt nach oben zu heben und es auf diese Art von den oberen Haken zu lösen.

4. HANDTÜCHER

- Die Handtücher immer gleichmäßig auf den Stangen verteilen (Abbildung 8-A).
- Niemals Handtücher oder Kleidung auf den Heizkörper legen (Abbildung 8-B).
- Die Handtücher niemals in mehreren Lagen übereinander legen und die Handtücher vor allem nicht zwischen der Stange und der Vorderseite des Heizkörpers einklemmen (Abbildung 8-C).

5. BEFEHLSBESCHREIBUNG UND FUNKTION

- Die folgenden Bedienelemente sind auf der Vorderseite verfügbar (Abbildung 9):
 - A - Stand-by
 - B - Erhöhen
 - C - Verringern
 - D - Modus
 - E - Anzeige

Das Produkt kann in 3 verschiedenen Modi betrieben werden: automatisch, programmiert oder frostfrei.

Automatischer Modus

In diesem Modus arbeitet das Produkt daran, die vom Benutzer eingestellte Komforttemperatur zu erreichen und aufrechtzuerhalten. Ein automatisches Energiemanagementsystem ermöglicht eine optimale Kontrolle des Verbrauchs und eine präzise Anpassung des Komfortniveaus, wobei die gewählte Temperatur automatisch über die Zeit konstant gehalten wird, in Übereinstimmung mit den Einstellungen des elektronischen Thermostats.

Im automatischen Modus ist auch eine spezielle Funktion verfügbar, die nach Wahl des Benutzers aktiviert wird und es

ermöglicht, das mögliche Öffnen eines Fensters zu erkennen und den Betrieb in den frostfreien Modus zu zwingen, um Energieverschwendung zu minimieren.

Programmierter Modus

Das Produkt kann für jeden Wochentag auf Stundenbasis programmiert werden. Für jede Stunde des Tages kann die zu erreichende/beizubehaltende Referenztemperatur definiert werden, wobei zwischen Comfort, Eco (dessen Wert der um 3,5°C reduzierten Comfort-Temperatur entspricht) oder Frostfrei gewählt werden kann.

 Im programmierten Modus ist die Erkennung offener Fenster deaktiviert, damit das Produkt dem vom Benutzer definierten Temperaturprofil korrekt folgen kann.

Frostfreier Modus

In diesem Modus wird der Thermostat automatisch so eingestellt, dass er 7±3°C hält.

6. VERWENDUNG DES HEIZGERÄTS

STAND-BY-TASTE

Verwenden Sie die  Taste, um das Produkt einzuschalten oder in den Standby-Modus zu versetzen. Wenn sich das Produkt im Stand-by-Modus befindet, erscheinen zwei weiße Striche auf dem Display:

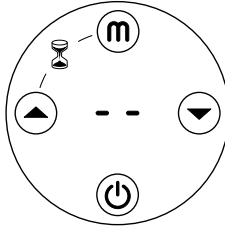

Wenn das Produkt eingeschaltet wird, wird es im automatischen Modus aktiviert. Auf dem Display wird für 3 Sekunden die Meldung "AU" und danach die eingestellte Temperatur angezeigt:

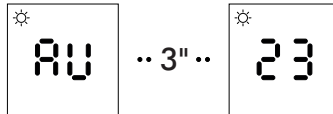

BETRIEBSARBEITEN

Durch Drücken der  Taste kann der automatische, programmierte oder frostfreie Modus ausgewählt werden, wie in Abschnitt 5 beschrieben:



Drücken Sie die  Taste, um vom automatischen in den programmierten Modus zu wechseln. Das Display zeigt "Pr" an.

Im Display leuchten zusätzlich das Uhrensymbol und das Symbol der eingestellten Betriebsart für die aktuelle Uhrzeit und den Tag (Komfort, Eco oder Frostschutz).

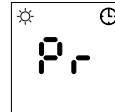



Drücken Sie die **(m)** Taste, um vom programmierten in den frostfreien Modus zu wechseln. Das Display zeigt für 3 Sekunden „FF“ und dann die erwartete Temperatur von 7,0 °C (nicht änderbar) und das Frostschutzmodus-Symbol leuchtet ebenfalls auf dem Display.

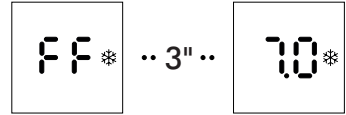

Drücken Sie die **(m)** Taste erneut, um zum automatischen Modus zurückzukehren und den Zyklus neu zu starten.

EINSTELLUNGEN

Mit den Tasten **(m)**, **(▲)** und **(▼)** können Sie die aktuelle Uhrzeit und den Tag, die Komforttemperatur einstellen und die Erkennung des Öffnens eines Fensters aktivieren oder deaktivieren. Tag „1“ entspricht MONTAG.



Drücken Sie die Taste **(m)** mindestens 3 Sekunden lang, um die Einstellungen ab der aktuellen Uhrzeit anzuzeigen/zu ändern.



Stellen Sie die aktuelle Stunde mit den Tasten **(▲)** und **(▼)** ein.



Drücken Sie die Taste **(m)**, um zur Einstellung der Minuten zu wechseln. Stellen Sie die aktuellen Minuten mit den Tasten **(▲)** und **(▼)** ein.



Drücken Sie die Taste **(m)**, um zur Einstellung des Tages zu wechseln. Stellen Sie den aktuellen Wochentag mit den Tasten **(▲)** und **(▼)** ein (1 = Montag).



Drücken Sie die Taste **(m)**, um zur Einstellung für die Erkennung Offener Fenster zu wechseln. Stellen Sie die Funktion mit den Tasten **(▲)** und **(▼)** auf ON oder OFF ein.

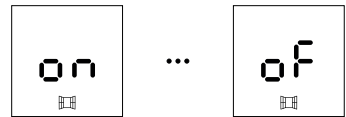

Drücken Sie die Taste **(m)**, um die Einstellungen zu verlassen und den Normalbetrieb wieder aufzunehmen.

OFFENE FENSTER ERKENNUNG

Diese Funktion ermöglicht es, ein offenes Fenster zu erkennen und automatisch die Betriebsart Frostschutz zu aktivieren. Wenn die Funktion aktiviert und bereit ist, den frostfreien Modus einzustellen, wenn ein offenes Fenster erkannt wird, ist im unteren Bereich des Displays ein Fenstersymbol sichtbar.

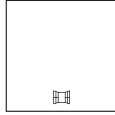

Wenn während des normalen Betriebs ein Temperaturabfall im Raum beobachtet wird, wird automatisch der Frostfrei-Modus aktiviert, um den Energieverbrauch zu senken. Das Display zeigt die Frostschutztemperatur und das Fenstersymbol blinkt, um anzuzeigen, dass die Fensteröffnungsfunktion aktiv ist.





Das Zurücksetzen des normalen Betriebs erfolgt nicht automatisch, sondern wird durch Drücken einer der Tasten des Produkts erreicht.



Der korrekte Betrieb dieser Funktion kann davon abhängen, wo der Heizkörper im Raum positioniert ist, ob Zugluft herrscht, wie die Außentemperatur ist und wie lange das Fenster geöffnet bleibt.

KOMFORTTEMPERATUR ANZEIGEN / ÄNDERN

Die Komforttemperatur wird im Automatikmodus angezeigt und kann durch Drücken der Taste  oder  geändert werden. Die Eco-Temperatur, die im programmierten Modus verwendet wird, kann nicht geändert werden und ist immer gleich der Comfort-Temperatur -3,5°C. Die Frostschutztemperatur ist ebenfalls fest und beträgt 7°C.

Hinweis: Die vom inneren Sensor des Produkts gemessene Temperatur ist repräsentativ für die Umgebungstemperatur in seiner Nähe und kann von der Temperatur abweichen, die mit anderen Instrumenten in anderen Bereichen des Raums gemessen wird. Dieser Unterschied kann von vielen Faktoren abhängen, darunter zum Beispiel:

- die Einbaulage: Einige Bereiche des Raums können durch Zugluft oder heiße Luftblasen beeinträchtigt werden, die die Sensormessung verändern;
- die Befestigung an einer Außenwand, die normalerweise kälter ist als Innenwände, was die Messung einer Temperatur implizieren kann, die niedriger ist als die tatsächliche Raumtemperatur;
- Instabile Bedingungen: Jede Bewertung muss unter stabilen Arbeitsbedingungen erfolgen. Dazu sollte die Komforttemperatur erst 120min nach einer vorherigen Änderung geändert werden. Es ist nämlich nicht möglich, die vom Produkt gehaltene Raumtemperatur korrekt zu bewerten, wenn die Komforttemperatur ständig in kurzer Zeit geändert wird.

Wenn unter stabilen Arbeitsbedingungen ein Unterschied zwischen der eingestellten Temperatur und der Raumtemperatur festgestellt wird, ist es möglich, die Messung des elektronischen Thermostats des Produkts anzupassen. Dieser Vorgang ist auch besonders nützlich, wenn der Heizgerät sehr nahe am Boden oder an der Decke installiert wird.

Um diese Korrektur einzustellen, gehen Sie wie folgt vor:



Drücken Sie die Taste **M** und HALTEN Sie sie gedrückt: auf dem Display wird die aktuelle Uhrzeit angezeigt.

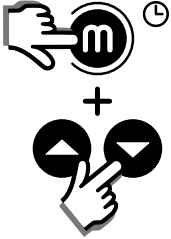
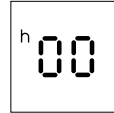

Drücken Sie gleichzeitig die Tasten **▲** und **▼**, während Sie weiterhin die Taste **M** gedrückt halten. Am Display wird „AL“ (Alignment/Anpassung) 2 Sekunden lang angezeigt und anschließend erscheint der aktuelle Wert der Anpassung (der Standardwert ist 0).

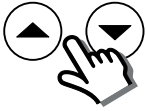

Verwenden Sie die Tasten **▲** und **▼**, um die gewünschte Anpassung einzustellen, indem Sie einen Wert zwischen -5 und +5 wählen.

Beispiel für eine Anpassung:
Wenn das Produkt auf 19°C eingestellt wurde, aber im Raum unter stabilen Bedingungen 20°C gemessen werden, ist die einzugebende Anpassung gleich $20-19 = 1$;

Wenn das Produkt hingegen auf 19°C eingestellt ist, im Raum aber beispielsweise 17°C gemessen werden, ist die einzugebende Anpassung gleich $17-19 = -2$.

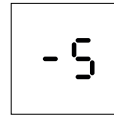

...

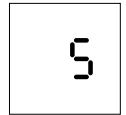

Drücken Sie die Taste **M**, um die Anpassung zu beenden und den Normalbetrieb wieder aufzunehmen.

WOCHENPROGRAMM

Der programmierte Modus ermöglicht es, für jede Tageszeit und jeden Wochentag unabhängig voneinander die gewünschte Temperatur einzustellen, indem Sie zwischen Komfort, Eco (entspricht der um 3,5°C verringerten Komforttemperatur) oder Frostfrei wählen.

Um den programmierten Modus zu aktivieren, drücken Sie die **M** Taste, bis das Display "Pr" anzeigt. Wenn das Produkt brandneu ist, ist das Standardprogramm das folgende:



Immer Frostfreier Betrieb außer Komfortbetrieb in den folgenden Stunden:

- montags bis freitags von 06:00 bis 08:00 Uhr;
- von Samstag bis Sonntag von 08:00 bis 10:00 Uhr.

Wenn Sie sich im programmierten Modus befinden, können Sie das Programm anzeigen/ändern, indem Sie die Tasten **▲** und **▼** gleichzeitig drücken.

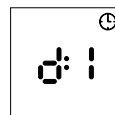
Am Display wird Tag 1 (Montag) angezeigt.



Wenn Sie die Tasten  und  drücken, werden die jeweiligen Stunden des Tages ausgehend von „00“ (Zeit zwischen 00:00 und 00:59) angezeigt.

Die für die gewählte Zeit eingestellte Referenztemperatur wird durch Einschalten des Frostfreisymbols (Temperatur von 7°C), des Eco-Symbols (Eco-Temperatur = Komfort - 3,5°C) oder des Komfort-Symbols (vom Benutzer eingestellte Komforttemperatur) angezeigt.

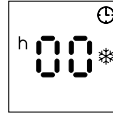

Die gewünschte Temperatur kann durch Drücken der Taste  geändert werden. Das Aufleuchten der Symbole in der oben beschriebenen Reihenfolge zeigt die Referenztemperatur an.

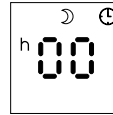
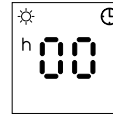
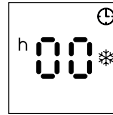

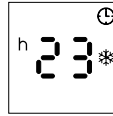

Verwenden Sie die Tasten  und  um die eingestellte Temperatur für jede Stunde von Tag 1, von 00 bis 23, anzuzeigen/zu ändern.



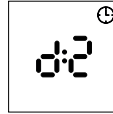

Um 23 Uhr können Sie durch erneutes Drücken der Taste  die Programmierung für Tag 2 aufrufen.

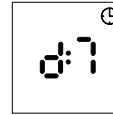
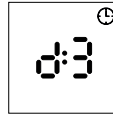

Sie können jetzt wählen, ob Sie die Temperatur der jeweiligen Stunden von Tag 2 anzeigen/ändern oder Tag 2 genau wie Tag 1 einstellen möchten. Im ersten Fall verwenden Sie die Tasten  und  wie bereits für Tag 1 beschrieben, im zweiten Fall

drücken Sie einfach erneut die Taste . Dadurch wird Tag 2 automatisch genau wie Tag 1 eingestellt und das System rückt zum Anfang von Tag 3 vor. Dieser Vorgang kann bis zur Programmierung von Tag 7 wiederholt werden.



Nach Abschluss der Programmierung für Tag 7 oder in einer beliebigen Zwischenphase der Programmierung kann durch Drücken der Taste  die Phase der Programmspeicherung aufgerufen werden. Die Meldung "OK" erscheint auf dem Display und das soeben eingegebene Programm wird gespeichert.

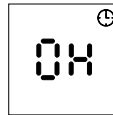





BEACHTEN:



- Es ist jederzeit möglich, den Anzeige-/Änderungsvorgang abzubrechen, indem die noch nicht gespeicherten Änderungen gelöscht werden, indem 30 Sekunden gewartet wird, ohne eine Taste zu berühren;
- Während der Programmierung sind die Heizelemente getrennt und das Produkt heizt nicht.

BOOST FUNKTION

Die BOOST-Funktion ermöglicht den zeitgesteuerten Betrieb des Heizkörpers für die gewünschte Dauer und ohne Raumtemperaturregelung. Nach Ablauf der gewählten Zeit kehrt der Heizkörper in den Modus zurück, der vor der Aktivierung der Timer-Funktion eingestellt war.

Um die Timer-Funktion zu aktivieren, gleichzeitig die Tasten  und  drücken. Die voreingestellte Zeit für die Timer-Funktion beträgt 60' und blinkt für einige Sekunden auf dem Display. Während dieser Phase kann die Dauer mit den Tasten  und  zwischen 60', 90' oder 120' (2h) geändert werden. Nach 5" hört die auf dem Display angezeigte Zeit auf zu blinken und die Timer-Funktion ist eingestellt. Ab jetzt zeigt das Display die verbleibende Zeit der Timer-Funktion an.

Wenn die verbleibende Zeit zwischen 1 und 2 Stunden liegt, werden die verbleibenden Minuten (1 bis 59) angezeigt und dann 3" lang die Zahl 1h. Wenn die verbleibende Dauer weniger als 1 Stunde beträgt, werden nur die verbleibenden Minuten (1 bis 59) angezeigt.

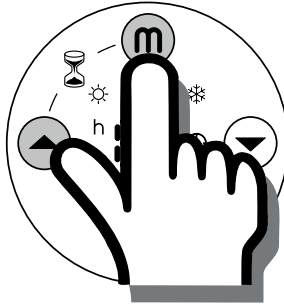

7. FEHLERBEHEBUNG

- Bei Überhitzung deaktiviert das Schutzsystem des Geräts automatisch das Heizelement. In diesem Fall:
 - Schalten Sie den Heizgerät aus und lassen Sie ihn für etwa 15/20 Minuten abkühlen;
 - Entfernen Sie mögliche andere Ursachen der Überhitzung (z.B.: Verstopfung vor dem Luftauslassgitter, Schmutzreste auf dem Produkt);
 - Schalten Sie den Heizgerät erneut ein und überprüfen Sie den korrekten Betrieb.
- Schalten Sie, wenn die Touchscreen-Befehle des Produkts nicht auf den digitalen Druck reagieren und nicht ordnungsgemäß funktionieren, den Heizgerät für wenigstens 30 Sekunden mit Hilfe des elektromechanischen Schalters auf der linken Seite des Produkts aus.

8. WARTUNG

- Dieses Produkt erfordert keine spezielle Wartung.
- Wir empfehlen, das Produkt mindestens alle 6 Monate mit einem trockenen Tuch zu reinigen.
- Falls das Produkt repariert werden muss, wenden Sie sich bitte an ein qualifiziertes Servicecenter.
- Falls das Netzkabel ersetzt werden muss, denken Sie daran, dass zwingend ein Kabel vom Typ 2x1,00mm² H05V2V2-F <HAR> verwendet werden muss. Dieser Vorgang muss von qualifizierten Technikern ausgeführt werden und niemals vom Endnutzer, um das Risiko einer Beschädigung und/oder Beeinträchtigung des Sicherheitsniveaus des Produkts zu vermeiden.

9. GESETZLICHE MITTEILUNGEN



Umweltschutz und Recycling

Damit Ihr Gerät während des Transports keine Schäden erleidet, wurde es sorgfältig verpackt. Um zum Umweltschutz beizutragen, bitten wir Sie, das für die Verpackung des Geräts verwendete Material angemessen zu entsorgen.

Entsorgung von gebrauchten Geräten

Die Geräte, die das nebenstehende Zeichen tragen, dürfen nicht zusammen mit dem Hausmüll entsorgt werden, sondern müssen getrennt gesammelt und entsorgt werden. Die Entsorgung von gebrauchten Geräten muss fachgerecht in Einklang mit den lokal geltenden Vorschriften und Gesetzen erfolgen.

Obligatorische Informationen für elektrische Geräte für das Heizen von Räumen

Modellkennung: ONSEN					
Daten	Symbol	Wert	Einheit	Daten	Einheit
Thermische Leistung				Art der thermischen Leistung, nur für elektrische Speichergeräte für das Heizen von Räumen (nur eine Option angeben)	
Thermische Nennleistung	P_{nom}	0,750	kW	manuelle Kontrolle der thermischen Belastung, mit integriertem Thermostat	nein
Thermische Mindestleistung (indikativ)	P_{min}	0,750	kW	manuelle Kontrolle der thermischen Belastung, mit Nachprüfung der Umgebungstemperatur und/oder Außentemperatur	nein
Maximale kontinuierliche thermische Leistung	$P_{max,c}$	0,750	kW	elektronische Kontrolle der thermischen Belastung, mit Nachprüfung der Umgebungstemperatur und/oder Außentemperatur	nein
Hilfsstromverbrauch				vom Ventilator unterstützte thermische Leistung	nein
Bei thermischer Nennleistung	$e_{l,max}$	0,000	kW	Art der thermischen Leistung/Kontrolle der Umgebungstemperatur (nur eine Option angeben)	
Bei thermischer Mindestleistung	$e_{l,min}$	0,000	kW	einphasige thermische Leistung ohne Kontrolle der Umgebungstemperatur	nein
Im Stand-by-Modus	$e_{l,SB}$	0,343	W	zwei oder mehrere manuelle Phasen ohne Kontrolle der Umgebungstemperatur	nein
				mit Kontrolle der Umgebungstemperatur mittels mechanischem Thermostat	nein
				mit elektronischer Kontrolle der Umgebungstemperatur	nein
				mit elektronischer Kontrolle der Umgebungstemperatur und Tagestimer	nein
				mit elektronischer Kontrolle der Umgebungstemperatur und Wochentimer	ja
				Weitere Kontrolloptionen (es ist möglich, mehrere Optionen auszuwählen)	
				Kontrolle der Umgebungstemperatur mit Anwesenheitserkennung	nein
				Kontrolle der Umgebungstemperatur mit Erkennung eines geöffneten Fensters	ja
				mit Option der Fernkontrolle	nein
				mit anpassbarer Startkontrolle	nein
				mit Begrenzung der Betriebszeit	nein
				mit Schwarzkugelsensor	nein
Kontakte	Ermete Giudici S.p.A. - via L. da Vinci, 27 - 20090 Segrate (MI) Italy				

Technische Richtwerte bei 230 V - 50 Hz Stromversorgung

Przed uruchomieniem grzejnika należy dokładnie zapoznać się z poniższymi instrukcjami, aby uniknąć uszkodzeń i niebezpiecznych sytuacji. Jakiegokolwiek użycie grzejnika inne niż określone w niniejszej instrukcji obsługi może spowodować pożar, porażenie prądem elektrycznym lub obrażenia i utratę gwarancji.

Gwarancja nie obejmuje wszelkich strat, uszkodzeń i utraty zdrowia powstałych w wyniku niewłaściwego użytkowania urządzenia. Prawa dotyczące gwarancji w kraju użytkowania nie są pomijane. Żaden z warunków niniejszej gwarancji nie wyłącza jakiegokolwiek warunków bądź gwarancji przewidzianych przepisami prawa krajowego, które nie mogą zostać uchylone ani zmienione.

Przed rozpoczęciem użytkowania usunąć opakowanie i sprawdzić integralność produktu. W przypadku wad lub uszkodzeń, nie próbuj naprawiać go samodzielnie i skontaktuj się z sprzedawcą.

Nie pozwalaj dzieciom bawić się opakowaniem i chronić środowisko poprzez utylizację opakowania zgodnie z krajowymi przepisami dotyczącymi przetwarzania odpadów.

1. DLA WŁASNEGO BEZPIECZEŃSTWA

- Ten grzejnik jest przeznaczony do użytku domowego i nie został przystosowany do użytku komercyjnego/przemysłowego, w samochodach, na statkach lub samolotach.
- Produkt może być stosowany przez dzieci od 8 roku życia oraz osoby o ograniczonych zdolnościach fizycznych, czuciowych lub umysłowych, lub z niedostatecznym doświadczeniem i wiedzą, pod warunkiem, że są one pod nadzorem osoby odpowiedzialnej za ich bezpieczeństwo lub zostały odpowiednio poinstruowane. Dzieci nie powinny bawić się produktem. Czyszczeniem i przeglądami użytkownika nie powinny się zajmować dzieci bez nadzoru.
- Dzieci poniżej 3 roku życia powinny być trzymane z dala od urządzenia, chyba że są pod stałą opieką.
- Dzieci pomiędzy 3 a 8 rokiem życia powinny tylko włączać i wyłączać urządzenie tylko wtedy, gdy umiejscowienie grzejnika na to pozwala, należy pamiętać o ciągłym nadzorze i wcześniejszym poinstruowaniu jak poprawnie korzystać z. Dzieci pomiędzy 3 a 8 rokiem życia nie powinny wyciągać wtyczki z gniazda, operować termostatem, czyścić grzejnik lub wykonywać kontrole użytkowe urządzenia.
- **UWAGA – Niektóre elementy tego produktu mogą być bardzo gorące i mogą spowodować oparzenia. Szczególną uwagę trzeba poświęcić, gdy w pobliżu znajdują się dzieci i osoby starsze.**
- Upewnij się, że zasilanie sieciowe odpowiada nominalnej mocy: 230-240V AC, 50Hz.
- Grzejnik posiada stopień ochrony IPX4. Można go więc stosować w łazienkach i innych miejscach narażonych na wilgoć, O ILE NIE JEST

ZAINSTALOWANY W GRANICACH WANNY LUB KABINY PRYSZNICOWEJ. Oznacza to, że nie może być zainstalowany w obszarze oznaczonych jako Strefa 1 z rys. 2.

- Podczas pracy, umieść grzejnik w bezpiecznej pozycji:
 - Daleko (1 m) od łatwopalnych przedmiotów lub mebli;
 - Pozostawiając wolne miejsce dla wylotu powietrza: 1m wolnej przestrzeni przed grzejnikiem;
 - Nie bezpośrednio pod gniazdkiem.
- Nie dopuszczaj by dzieci lub zwierzęta mogły dotknąć lub bawić się urządzeniem. Pamiętaj! Kratka wylotu powietrza nagrzewa się podczas pracy.
- Nie używaj grzejnika w pomieszczeniach z gazem wybuchowym lub podczas korzystania z łatwopalnych rozpuszczalników, lakierów lub klejów.
- Jeśli przewód jest uszkodzony trzeba go wymienić, nie rób tego samodzielnie! Dostarcz produktu do autoryzowanego centrum napraw lub do osoby posiadającej odpowiednie kwalifikacje.
- Urządzenie musi być zamontowane tak, aby wtyczka była zawsze wygodnie dostępna.
- Nie należy montować urządzenia na ścianach wykonanych z materiałów syntetycznych.
- **OSTRZEŻENIE:** Nie używaj grzejnika w małych pomieszczeniach w których znajdują się osoby niezdolne do jego samodzielnego opuszczenia, chyba że znajdują się pod nadzorem.
- **OSTRZEŻENIE:** Aby zmniejszyć ryzyko pożaru umieść urządzenie tak, aby wylot powietrza był minimum 1 metr od tkanin, firanek i innych łatwopalnych materiałów.
- **OSTRZEŻENIE:** To urządzenie jest przeznaczone wyłącznie do suszenia tekstyliów wypranych w wodzie.

2. TWÓJ PRODUKT

- Oprócz wybranego przez Ciebie urządzenia, w skład zestawu wchodzi (ilustracja 1):
 - Metalowy uchwyt do montażu ściennego (przymocowany do grzejnika);
 - 4 kołki o wymiarach 8x50mm;
 - 4 śruby o wymiarach 5x60mm;
 - 2 szt relingów na ręczniki;
 - 4 szt śrub 3,9x13 mm do mocowania relingów do grzejnika;
- Jeśli w zestawie brakuje elementów, bądź są one uszkodzone, skontaktuj się ze sprzedawcą.

3. MONTAŻ ŚCIENNY

- Korzystaj z grzejnika tylko jeśli został zamontowany na ścianie, w położeniu pionowym.
- Grzejnik jest wyposażony w układ podwójnej izolacji elektrycznej (klasa II), a zatem nie wymaga uziemienia.
- Grzejnik musi być prawidłowo zainstalowany, zgodnie z przepisami obowiązującymi w kraju użytkowania.
- W wilgotnych pomieszczeniach, takich jak kuchnia lub łazienka, gniazdko powinno być zainstalowane minimum 25cm od podłogi. Podłączenie elektryczne powinno być wyposażone w dwubiegunowy przełącznik z minimalną przerwą stykową umożliwiającą pełne rozłączenie zgodnie z kategorią III nadmiaru napięcia.
- Jeśli chcesz przymocować jeden lub oba relingi na ręczniki do produktu, przed przymocowaniem urządzenia do uchwytu ściennego użyj dostarczonych śrub, jak pokazano na rysunku 3.
- Zawsze przestrzegaj minimalnych odległości od ścian, mebli i/lub przedmiotów, jak pokazano na rysunku 4. Nigdy nie instaluj produktu w taki sposób, aby odległość między podłogą a dolną stroną produktu była mniejsza niż 30cm:
 - Zdejmij wspornik ścienny przymocowany do tylnej części grzejnika, zwalniając 2 dolne mocowania;
 - Za pomocą ołówka zaznacz położenie punktów montażowych (rysunek 5).
 - Wywierć 4 otwory w zaznaczonych wcześniej punktach i włóż plastikowe kołki;
 - Przymocuj wspornik do ściany za pomocą 4 dostarczonych śrub (rysunek 6);
 - Zawieś grzejnik na wsporniku, zaczynając od 2 górnych mocowań, a następnie zatrzasknij 2 dolne mocowania (rysunek 7);
 - W przypadku późniejszego zdjęcia grzejnika z uchwytu, zalecamy rozpocząć najpierw od dwóch dolnych mocowań, a następnie odblokować górne.

4. RĘCZNIKI

- Zawsze rozkładaj ręczniki na relingach (rysunek 8-A);
- Nie kładź ręczników na grzejniku (rysunek 8-B);
- Nie zwijaj ręczników między relingiem a przednią powierzchnią (zdjęcie 8-C).

5. OPIS FUNKCJI

- Poniższe funkcje są dostępne na panelu frontowym (rysunek 9):
 - A - Czuwanie
 - B - Zwiększenie
 - C - Zmniejszenie
 - D - Tryb
 - E - Wyświetlacz

Grzejnik może działać w 3 różnych trybach: automatycznym, zaprogramowanym i przeciwzamrożeniowym:

Tryb automatyczny

W trybie automatycznym grzejnik osiąga i utrzymuje ustawioną temperaturę "Komfortową". System automatycznego zarządzania energią pozwala na optymalną kontrolę zużycia mocy i precyzyjne ustawienie i utrzymanie pożądanej temperatury, utrzymując ją stałą z ustawieniem termostatu.

W trybie automatycznym jest możliwe włączenie specjalnej funkcji, aktywowanej przez użytkownika (w standardzie funkcja jest wyłączona), która umożliwia wykrycie otwartego okna i automatycznie przełącza grzejnik w tryb przeciwzamrożeniowy, aby zminimalizować straty energii.

Tryb zaprogramowany

Urządzenie może być zaprogramowane na każdą godzinę, każdego dnia tygodnia. Na każdą godzinę można ustawić temperaturę, którą grzejnik ma osiągnąć/utrzymać, wybierając między Komfortową, Eko (która jest równa temperaturze komfortowa minus 3,5°C) lub przeciwzamrożeniową.



W trybie zaprogramowanym czujnik otwartego okna jest wyłączony, aby urządzenie mogło prawidłowo ustawiać temperaturę wybraną przez użytkownika.

Tryb przeciwzamrożeniowy

W tym trybie termostat jest ustawiony na automatyczne utrzymywanie temperatury $7\pm 3^{\circ}\text{C}$.

6. UŻYWANIE

PRZYCIŚK TRYBU GOTOWOŚCI

Naciśnij przycisk  aby włączyć urządzenie lub przełączyć je w tryb gotowości. Kiedy urządzenie jest w trybie gotowości na wyświetlaczu pojawiają się dwie białe kreski:

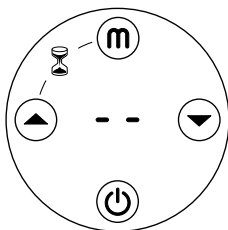

Po uruchomieniu się urządzenie jest w trybie Automatem. Na wyświetlaczu przez 3 sekundy widać napis "AU", po czym pokazuje się temperatura:

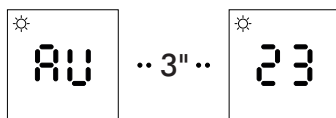

TRYBY PRACY

Naciśnij przycisk  aby wybrać tryb automatyczny, zaprogramowany lub przeciwwamrożeniowy, są one opisane w paragrafie 5:



Naciśnij  przycisk, aby zmienić tryb z automatycznego na zaprogramowany. Wyświetlacz pokazuje "Pr".

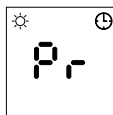

Symbol zegara oraz ikona odpowiadająca obecnemu trybowi operacji (Komfortowa, Eko, przeciwwamrożeniowy) również są widoczne na wyświetlaczu.



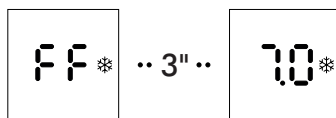

Naciśnij przycisk  aby zmienić tryb z zaprogramowanego na przeciwwamrożeniowy. Wyświetlacz pokazuje "FF" przez trzy sekundy a następnie oczekiwaną temperaturę - 7.0°C (niemodyfikowalną) oraz symbol trybu przeciwwamrożeniowego.



Naciśnij przycisk  ponownie, aby wrócić do trybu automatycznego i rozpocząć cykl od nowa.

USTAWIENIA

Przyciski ,  i  pozwalają ustawić obecną godzinę i dzień tygodnia, temperaturę Komfortową oraz włączyć/wyłączyć czujnik otwartego okna. Dzień "1" odpowiada poniedziałkowi.



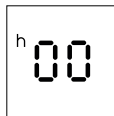

Naciśnij przycisk  przez 3 sekundy, aby wyświetlić albo zmienić ustawienia, począwszy od czasu. Ustal obecną godzinę przyciskami  i .

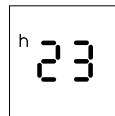

...



Naciśnij przycisk  aby przejść do ustawiania minut. Ustaw obecną minutę przyciskami  i .

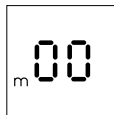

...

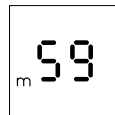

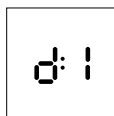

Naciśnij przycisk  aby przejść do ustawiania dnia.
Ustaw obecny dzień przyciskami  i  (1=poniedziałek).

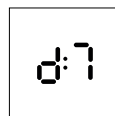

...



Naciśnij przycisk  aby przejść do ustawiania czujnika otwartego okna.
Włącz lub wyłącz funkcję przyciskami  i .

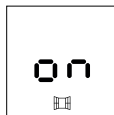

...

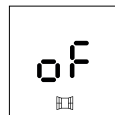

Naciśnij przycisk  aby wyjść z ustawień i przywrócić grzejnik do regularnego funkcjonowania.

CZUJNIK OTWARTEGO OKNA

Dzięki tej funkcji grzejnik może wykryć, kiedy w pomieszczeniu jest otwarte okno i automatycznie włączyć tryb przeciwwzmożeniowy. Kiedy funkcja jest włączona, w dolnej części wyświetlacza pojawia się ikona okna.

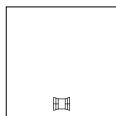

Jeżeli podczas pracy urządzenia wykryte zostanie gwałtowne obniżenie temperatury, tryb przeciwwzmożeniowy aktywuje się automatycznie, aby ograniczyć zużycie energii. Wyświetlacz pokazuje temperaturę przeciwwzmożeniową, a ikona okna miga, co wskazuje na prawidłową pracę funkcji czujnika otwartego okna.

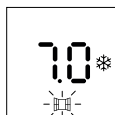



Przywrócenie normalnego funkcjonowania nie jest automatyczne – aby przywrócić urządzenie do normalnej pracy należy nacisnąć dowolny przycisk.



Poprawne działanie tej funkcji zależy od miejsca montażu grzejnika, obecności przeciągów, temperatury zewnętrznej oraz tego jak długo okno zostaje otwarte.

POKAŻ/ZMIĘŃ TEMPERATURĘ “KOMFORTOWĄ”

Temperatura Komfortowa jest wyświetlana podczas pracy w trybie Automatycznym i regulowana przyciskami  i . Temperatura Eko jest stała i równa się temperaturze Komfortowa - 3.5°C. Temperatura przeciwzamrożeniowa również jest stała i wynosi 7°C

Uwaga: Temperatura mierzona przez wewnętrzny czujnik produktu jest reprezentatywna dla temperatury otoczenia i może być inna od temperatury mierzonej innymi metodami, w innych miejscach pokoju. Różnica zależy od wielu czynników, między innymi od:

- Miejsca montażu - niektóre miejsca w pokoju mogą być narażone na przeciągi, które będą miały wpływ na pomiary sensora.
- Przymocowania na zewnętrznej ścianie - naturalnie zimniejszej od ścian wewnętrznych, może wpłynąć na pomiar i wskazywać inną temperaturę niż rzeczywistą temperaturę pomieszczenia;
- Niestabilnych warunków - każdy pomiar musi być przeprowadzony w ustabilizowanych warunkach. Z tego powodu temperatura “Komfortowa” powinna być zmieniana najwcześniej 120 minut po poprzedniej zmianie. Prawidłowy pomiar temperatury pomieszczenia jest niemożliwy, jeżeli temperatura “Komfortowa” jest zmieniana wielokrotnie w krótkim odcinku czasu.



W przypadku wykrycia różnicy pomiędzy temperaturą zadaną a temperaturą pokojową w stabilnych warunkach pracy, istnieje możliwość skorygowania pomiaru dokonywanego przez termostat produktu. Operacja ta jest również szczególnie przydatna w przypadku montażu grzejnika bardzo blisko podłogi lub sufitu.

Aby ustawić tę korektę, wykonaj następujące czynności:



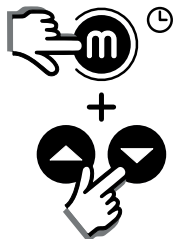
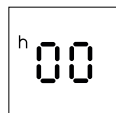

Naciśnij i PRZYTRZYMAJ przycisk : na ekranie pojawi się aktualna godzina.

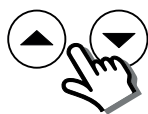

Trzymając wciśnięty klawisz , naciśnij jednocześnie klawisze  i . Na wyświetlaczu pojawi się napis „AL” (korekta) przez 2 sekundy, a następnie rzeczywistą wartość korekty (wartość domyślna to 0).



Użyj klawiszy  i , aby ustawić pożądaną korektę, wybierając wartość z zakresu od -5 do +5.

Przykład ustawienia:

Jeśli produkt został ustawiony na 19°C, ale w pomieszczeniu jest 20°C, zmierzzone w stabilnych warunkach, ustawienie do wstawienia wynosi 20-19 = 1;

Z drugiej strony, jeśli produkt jest ustawiony na 19°C, ale w pomieszczeniu, na przykład, jest 17°C, ustawienie do ustawienia wynosi 17-19 = -2.

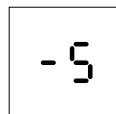

...

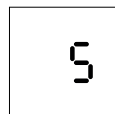

Naciśnij przycisk  aby zatwierdzić i wznowić normalne funkcjonowanie urządzenia.

PROGRAM TYGODNIOWY

Tryb zaprogramowany pozwala na ustawienie pożądanej temperatury na każdą godzinę, każdego dnia tygodnia, dając wybór między temperaturą Komfortową, Eko i przeciwzamrożeniową.



Aby włączyć tryb zaprogramowany naciśnij  aż na wyświetlaczu wyświetli się napis "Pr". Jeżeli produkt jest nowy, domyślny program wygląda następująco:

Zawsze tryb przeciwzamrożeniowy, temperatura Komfortowa w godzinach:

- od 06:00 do 08:00 od poniedziałku do piątku;



- od 08:00 do 10:00 w sobotę i niedzielę.

W trybie programu możesz wyświetlić/zmodyfikować program

naciskając naraz przyciski  i .

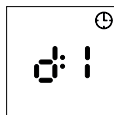
Wyświetlacz pokazuje dzień 1 (poniedziałek).



Za pomocą przycisków  i  zmieniamy godzinę, zaczynając od "00" (godzina między 00:00 a 00:59). Pożądana temperatura na każdą godzinę jest wyświetlana za pomocą odpowiedniej ikony:

- Płatek śniegu - temperatura przeciwzamrożeniowa (7°C)

- Księżyc - temperatura Eko (Komfortowa -3.5°C)

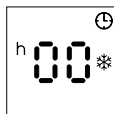

- Słońce - temperatura Komfortowa (ustawiona przez użytkownika).

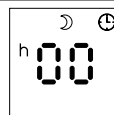
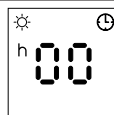
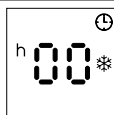

Pożądana temperatura może być zmieniona przez naciśnięcie

 Zapalenie się ikon, według poniższego schematu, wskazuje odpowiednią temperaturę



Use the  and  keys to view/modify the temperature set for each of the hours of day 1, from 00 to 23.

Użyj przycisków  i  aby wyświetlić/zmodyfikować temperaturę ustawioną na każdą godzinę dnia 1, zaczynając od godziny 00 do 23.

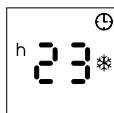

Po godzinie 23 naciśnięcie  przenosi nas do programowania dnia 2.

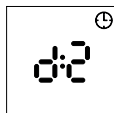

Na tym etapie można wybrać między wyświetlaniem/modyfikacją temperatury na poszczególne godziny dnia 2 lub zduplikować program z dnia 1 na dzień 2.

Wyświetlanie/modyfikacja przebiega jak w opisie dnia pierwszego za pomocą przycisków  i .

By zduplikować program należy nacisnąć przycisk .

Po naciśnięciu przycisku system duplikuje program z dnia 1 na dzień 2 i automatycznie przechodzi na dzień 3. Ten proces można powtarzać aż do dnia 7.

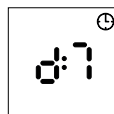
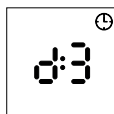

Na koniec programowania dnia 7 lub w dowolnym momencie





wcześniej, naciśnięcie przycisku  pozwala na zapisanie programu. Wyświetlacz pokazuje "OK" i program jest zapisany.





- W dowolnym momencie można opuścić proces programowania i anulować zmiany zostawiając urządzenie na 30 sekund, bez dotykania żadnego przycisku.
- Podczas programowania element grzewczy jest rozłączony; urządzenie nie grzeje.

BOOST FUNCTIE

Funkcja Boost umożliwia aktywację czasowego działania z maksymalną mocą bez sterowania termostatem. Po zakończeniu tej pracy grzejnik powraca do trybu pracy przed włączeniem funkcji Boost. Aby uaktywnić funkcję należy nacisnąć jednocześnie  i . Domyślny czas trwania 60 minut miga na wyświetlaczu. Czas trwania można wybrać pomiędzy wartościami 60, 90 lub 120 minut (2h) za pomocą przycisków  i . 5 sekund po ostatnim wyborze funkcja jest aktywna. Jeśli pozostały czas jest mniejszy lub równy 59 min, wyświetlacz pokazuje pozostałe minuty grzania. Jeśli jest wyższa, wyświetlacz pokazuje pozostałe minuty poprzedzone słowem „1h” wyświetlanym przez 3 sekundy.

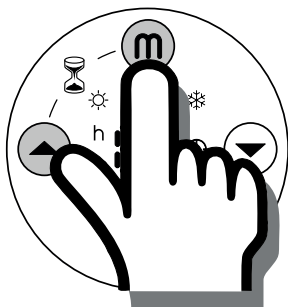

7. ROZWIĄZYWANIE PROBLEMÓW

- W przypadku przegrzania urządzenie automatycznie wyłącza element grzewczy i wiatrak. W tej sytuacji:
 - Odłącz urządzenie od prądu i daj mu 15-20 minut na ostygnięcie.
 - Usuń inne możliwe przyczyny przegrzania (zasłonięty wlot/wylot powietrza, nagromadzenia brudu).
 - Podłącz urządzenie ponownie i sprawdź, czy działa prawidłowo.
- Jeżeli przyciski dotykowe są zablokowane lub nie odpowiadają, wyłącz urządzenie głównym wyłącznikiem, który znajduje się po lewej stronie grzejnika. By włączyć urządzenie użyj tego samego przycisku.

8. KONSERWACJA

- Ten produkt nie wymaga specjalnej konserwacji.
- Wyczyść produkt moką szmatką raz na 6 miesięcy.
- Jeżeli produkt wymaga naprawy skontaktuj się z autoryzowanym serwisem.
- Przy wymianie kabla zasilającego, użyj kabla typu 2x1,00mm² H05V2V2-F HAR. Ta czynność musi zostać wykonana przez wykwalifikowanego elektryka.

9. INFORMACJA PRAWNA



Środowisko i recykling

Pomóż nam chronić środowisko naturalne przez utylizację opakowania zgodnie z obowiązującymi przepisami państwowymi.

Recykling starych urządzeń

Urządzenia z tym znakiem nie mogą być wyrzucane jako odpady komunalne. Muszą być utylizowane zgodnie z normami lokalnymi.

Informacje wymagane dla lokalnych elektrycznych ogrzewaczy pomieszczeń

Model: ONSEN					
Opis	Symbol	Wartość	Jednostka	Opis	
Moc grzewcza				Rodzaj wejścia ciepła, dla elektrycznych miejscowych ogrzewaczy pomieszczeń (wybierz jeden)	
Nominalna moc grzewcza	P_{nom}	0,75	kW	Ręczna regulacja ładowania ciepła, z wbudowanym termostatem	nie
Minimalna moc grzewcza(orientacyjny)	P_{min}	0,75	kW	Ręczna regulacja ładowania ciepła z odczytem temperatury pokojowej i/lub temperatury zewnętrznej	nie
Maksymalna ciągła moc grzewcza	$P_{max,c}$	0,75	kW	Elektroniczna regulacja ładowania ciepła z odczytem temperatury pokojowej i/lub temperatury zewnętrznej	nie
Dodatkowe zużycie energii elektrycznej				Ciepło wspomagane wentylatorem	nie
Przy nominalnej mocy grzewczej	$e_{l,max}$	0,000	kW	Rodzaj mocy grzewczej/kontroli temperatury pokojowej (wybierz jedną)	
Przy minimalnej mocy grzewczej	$e_{l,min}$	0,000	kW	Jednostopniowe wytwarzanie ciepła i brak kontroli temperatury w pomieszczeniu	nie
W trybie czuwania(standby)	$e_{l,SB}$	0,343	W	Dwa lub więcej ręcznych etapów, brak kontroli temperatury w pomieszczeniu	nie
				Z ręczną regulacją temperatury pomieszczenia	nie
				Z elektroniczną regulacją temperatury pomieszczenia	nie
				Elektroniczna regulacja temperatury w pomieszczeniu plus zegar dzienny	nie
				Elektroniczna regulacja temperatury w pomieszczeniu plus zegar tygodniowy	tak
				Inne opcje sterowania (możliwe wielokrotne wybory)	
				Kontrola temperatury w pomieszczeniu, z wykrywaniem obecności	nie
				Kontrola temperatury w pomieszczeniu, z wykrywaniem otwartego okna	tak
				Z opcją kontroli odległości	nie
				Z adaptacyjną kontrolą startu	nie
				Z ograniczeniem czasu pracy	nie
				Z czujnikiem black bulb	nie
Dane producenta	Ermete Giudici S.p.A. - via L. da Vinci, 27 - 20090 Segrate (MI) Italy				

Wartości odniesienia przy 230V 50Hz

Citiți cu atenție aceste instrucțiuni înainte de a utiliza produsul, pentru a evita deteriorarea sau apariția unor situații periculoase. Orice utilizari a produsului, altele decât cele indicate în acest manual, poate provoca incendii, pericole electrice sau răniri și va anula orice garanție.

Garanția nu se aplică defecțiunilor, pierderilor, vătămărilor sau deteriorărilor cauzate de utilizarea incorectă a produsului. Toate drepturile legale în acest domeniu rămân garantate. Nici o garanție nu poate exclude sau modifica condițiile de garantare reglementate de legile statului care nu pot fi excluse sau modificate în niciun caz.

Înainte de fiecare operație, scoateți cu atenție ambalajul și verificați integritatea perfectă a produsului. Dacă se înregistrează defecțiuni sau deteriorări, nu instalați și nu încercați să reparați echipamentul! Contactați distribuitorul!

Nu lăsați ambalajul la îndemâna copiilor și nu aruncați componentele acestuia decât în conformitate cu reglementările în vigoare.

1. PENTRU SIGURANTA DVS.

- Acest produs este destinat uzului casnic și nu este adecvat pentru utilizare pe vehicule, bărci sau aeronave.
- Aparatul poate fi utilizat de copii cu vârsta de minim 8 ani și de persoane cu capacitate fizică, senzorială și mentală redusă sau fără experiență și cunoștințe necesare, numai sub supraveghere sau după ce au fost instruiți să folosească echipamentul în siguranță și să înțeleagă pericolele inerente acestuia. Copiii nu trebuie să se joace cu aparatul. Curățarea și întreținerea necesare bunei funcționări a aparatului nu trebuie efectuate de copii fără supraveghere.
- Copiii sub 3 ani nu trebuie să se apropie de produs fără supravegherea unui adult.
- Copiii cu vârste cuprinse între 3 și 8 ani pot doar porni/opri aparatul atât timp cât acesta a fost instalat și poziționat în conformitate cu condițiile normale de utilizare și sunt supravegheați sau instruiți în mod corespunzător cu privire la utilizarea corectă și sigură a produsului și au înțeles pericolul acestuia. Copiii cu vârste cuprinse între 3 și 8 ani nu pot conecta sau programa produsul, nu îl pot curăța sau întreține.
- **ATENȚIE: Unele părți ale acestui produs pot deveni foarte fierbinți și pot cauza arderi. O atenție deosebită trebuie acordată în prezența copiilor sau a oamenilor vulnerabili.**
- Asigurați-vă că sursa de alimentare corespunde datelor de calibrare: 230-240V ~, 50Hz.
- Produsul are un nivel dublu de protecție împotriva apei: IPX0 când este folosit ca încălzitor mobil și IPX4 când este instalat pe perete. Respectați reglementările țării în care produsul este instalat pentru a

fi utilizat în medii diferite. Când este instalat pe perete, acesta poate fi folosit în bai atata timp cat nu se afla in perimetrul vanei sau dusului. Prin urmare, produsul nu poate fi instalat în zonele indicate ca volum 1 în diagrama din figura 1. Dacă este folosit ca incalzitor mobil, asigurați-vă că convectorul nu este accesibil de la cadă, duș sau piscină.

- În timpul funcționării, așezați convectorul într-o poziție sigură, adică:
 - cel puțin la 1 m de obiecte inflamabile sau mobile
 - lăsând grilajul de evacuare a aerului liber, neacoperit
 - nu se află niciodată imediat sub o priză electrică
- Nu lăsați animalele sau copiii să se joace sau să atingă suportul convectorului. Atenție! În timpul funcționării, grilajul de evacuare a aerului poate deveni foarte fierbinte (peste 90°C);
- Nu utilizați convectorul în încăperi saturate cu gaze explozive, vapori generați de solvenți și lacuri sau în orice tip de vapori/gaze inflamabile.
- Dacă cablul este deteriorat și trebuie să îl înlocuiți, nu efectuați această operațiune singur. Trimiteti convectorul la un centru de reparații autorizat deoarece este necesara interventia unui personal special instruit pentru a evita orice risc de deteriorare.
- Convectorul trebuie să fie poziționat astfel încât priza sa fie intotdeauna accesibila.
- Nu instalați produsul pe pereți din material sintetic.
- ATENȚIE: Nu utilizați convectorul în încăperi mici atunci când sunt ocupate de persoane care nu pot părăsi singure încăperea, decât dacă sunt sub supravegherea unei persoane responsabile de siguranța acestora;
- ATENȚIE: Pentru a reduce riscul de incendiu, păstrați țesăturile departe de orice alt material inflamabil si la cel puțin 1 m distanță de grila de evacuare a aerului.
- ATENȚIE: Acest aparat electrocasnic este destinat numai pentru uscare textilelor spălate în apă.

2. PRODUSUL D-VS.

- Ce mai cuprinde pachetul pe langa aparatul de incalzire (image1):
 - N° 1 suporti metalici pentru montajul pe perete (fixati pe radiator);
 - N° 4 dibluri de plastic 8x50mm;
 - N° 4 5x60mm suruburi cap stea pentru a fixa suportii de perete;
 - N° 2 bare pentru prosoape;
 - N° suruburi de 3,9x13mm pentru fixarea barelor la incalzitor.
- Adresati-va dealer-ului daca ceva este stricat sau lipseste.

3. MONTAJUL PE PERETE

- Fixați încălzitorul doar în poziție verticală;
- Acest încălzitor este prevăzut cu un circuit dublu de izolație electrică (clasa II) și nu necesită o conexiune la împământare.
- Acest încălzitor trebuie instalat corect în conformitate cu reglementările în vigoare în țara de instalare.
- În spațiile umede precum băi sau bucătării, terminalul de conectare trebuie instalat la cel puțin 25 cm deasupra podelei. Conexiunea electrică la sursa de alimentare trebuie să fie prevăzută și cu un întrerupător bipolar cu un spațiu minim între contacte care să permită deconectarea completă conform condițiilor de supratensiune a III-a.
- Respectați întotdeauna distanțele minime față de pereți, mobilier și/sau obiecte, așa cum este indicat în imaginea 3.
- Nu instalați niciodată produsul astfel încât distanța dintre podea și partea inferioară a produsului să fie mai mică de 30cm:
 - Scoateți suportul de perete fixat pe spatele aparatului, prin eliberarea celor 2 arcuri inferioare;
 - Utilizați un creion pentru a marca poziția punctelor de fixare (imaginea 5).
 - Faceți cele 4 găuri în punctele marcate anterior și introduceți diblurile din plastic;
 - Fixați suportul de perete folosind cele 4 șuruburi furnizate (imaginea 6);
 - Agățați radiatorul de suport începând cu cele 2 puncte de fixare superioare, apoi faceți clic pe cele 2 puncte de fixare inferioare în poziție (imaginea 7);
 - În cazul în care trebuie să scoateți radiatorul din suport într-o etapă ulterioară, vă recomandăm să eliberați mai întâi cele două puncte de fixare inferioare și apoi cele superioare.

4. PROSOAPE

- Întindeți întotdeauna prosoapele peste barele de susținere (imaginea 8-A);
- Nu așezați prosoapele deasupra produsului (poza 8-B);
- Nu rulați prosoapele între bară și suprafața frontală (figura 8-C).

5. DESCRIEREA COMENZILOR ȘI A FUNCȚIONĂRII

- Următoarele comenzi sunt disponibile pe panoul frontal (imaginea 9):
 - A - Așteptare
 - B - Creștere
 - C - Descreștere
 - D - Mod
 - E - Afișaj

Aparatul poate fi operat în 3 moduri diferite: automat, programat sau anti-îngheț.

Modul Automat

În acest mod, produsul lucrează pentru a atinge și menține temperatura de Confort setată de utilizator. Un sistem automat de gestionare a puterii permite controlul optim al consumului și ajustarea precisă a nivelului de confort menținând automat temperatura selectată constantă în timp, în conformitate cu ce a fost setat pe termostatul electronic. În modul automat este disponibilă și o funcție specială, care este activată la alegerea utilizatorului, care permite detectarea posibilei deschideri a unei ferestre și forțarea funcționării în modul fără îngheț pentru a minimiza risipa de energie.

Modul Programat

Produsul poate fi programat, pe bază de oră, pentru fiecare zi a săptămânii. Pentru fiecare oră a zilei se poate defini temperatura de referință care trebuie atinsă/menținută, alegând între Confort, Eco (a cărui valoare este egală cu temperatura Confort redusă cu 3,5°C) sau anti-îngheț.

În modul programat, funcția de detectare a ferestrei deschise este dezactivată, astfel încât produsul să poată urmări corect profilul de temperatură definit de utilizator.

Modul anti-îngheț

În acest mod, termostatul este setat automat să mențină $7\pm 3^{\circ}\text{C}$.

6. FOLOSIREA ÎNCĂLZITORULUI

BUTONUL STAND-BY

Apăsați  pentru a porni sau a pune aparatul în Stand-by. Când este în Stand-by, vor apărea pe ecran două liniițe:

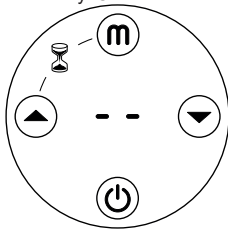

Când aparatul este pornit, acesta se activează în modul automat. Mesajul „AU” este afișat timp de 3 secunde pe afișaj și, după aceea, este afișată temperatura setată:

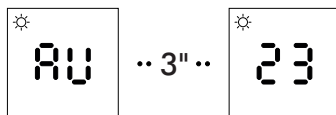

MODURILE DE OPERARE

Apăsând butonul  veți putea selecta modul Automat, Programat sau Anti-îngheț după cum este descris în paragraful 5:



Apăsați tasta  pentru a comuta de la modul automat la modul programat. Afișajul arată "Pr".

Simbolul ceasului și pictograma referitoare la modul de funcționare setat pentru ora și ziua curente (confort, eco sau anti-îngheț) se aprind de asemenea pe afișaj.

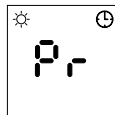

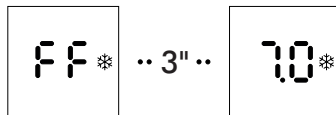

Apăsați tasta  pentru a comuta de la modul programat la modul anti-îngheț. Afișajul arată „FF” timp de 3 secunde și apoi temperatura așteptată de 7,0°C (nemodificabil) și simbolul modulului antiîngheț se aprinde și pe afișaj.

Apăsați din nou butonul  pentru a reveni la modul automat și a reporni ciclul.





SETĂRI

Butoanele   și  vă permit să setați ora și ziua curente, temperatura de Confort și să activați sau dezactivați detectarea deschiderii unei ferestre. Ziua „1” corespunde la LUNI.





Apăsați butonul  timp de cel puțin 3 secunde pentru a vizualiza/modifica setările începând cu ora.

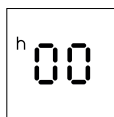

Setați ora curentă folosind butoanele  și .

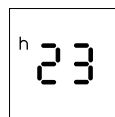

...





Apăsați butonul  pentru a comuta la setarea minutelor.

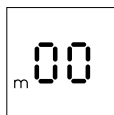

Setați minutele folosind butoanele  și .

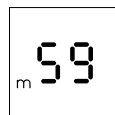

...





Apăsați butonul  pentru a comuta la setarea zilei.

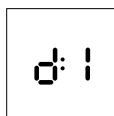

Setați ziua curentă a săptămânii  și  folosind butoanele (1 = luni).

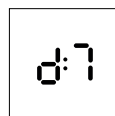

...



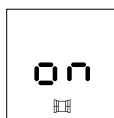

Apăsați butonul  pentru a comuta la setarea de detectare a ferestrei deschise.

Setați funcția ON sau OFF folosind  și  butoanele.

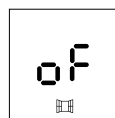

...



Apăsați butonul  pentru a ieși din setări și a relua funcționarea normală.

DETECTAREA FERESTREI DESCHISE

Această funcție face posibilă detectarea unei ferestre deschise și activarea automată a modului de funcționare Anti-îngheț. Când funcția este activată și gata pentru a seta modul fără îngheț dacă este detectată o fereastră deschisă, o pictogramă de fereastră este vizibilă în zona inferioară a afișajului.

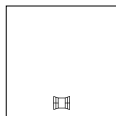

Dacă în încăpere se observă o scădere a temperaturii în timpul funcționării normale, modul anti-îngheț este activat automat pentru a economisi consumul de energie. Afișajul arată temperatura anti-îngheț și pictograma ferestrei clipește pentru a arăta că funcția fereastră deschisă funcționează.





Resetarea funcționării normale nu este automată ci se realizează prin apăsarea unuia dintre butoanele produsului.



Funcționarea corectă a acestei funcții poate depinde de locul în care este poziționat radiatorul în cameră, de prezența curenților de aer, de temperatura exterioară și de cât timp rămâne fereastra deschisă.

AFIȘAȚI / MODIFICAȚI TEMPERATURA DE CONFORT

Temperatura de confort este afișată în modul automat și poate fi modificată prin apăsarea tastei  sau .

Temperatura Eco, utilizată în modul programat, nu poate fi modificată și este întotdeauna aceeași cu temperatura Confort 3,5°C. Temperatura anti-îngheț este de asemenea, fixă și egală cu 7°C.

Notă: Temperatura măsurată de senzorul interior al produsului este reprezentativă pentru temperatura ambiantă din apropiere și poate diferi de temperatura măsurată cu alte instrumente din alte zone ale încăperii. Această diferență poate depinde de mulți factori, inclusiv, de exemplu:

- poziția de instalare: unele zone ale încăperii pot fi afectate de curenți de aer sau saci de aer cald care modifică măsurarea senzorului;
- fixarea pe un perete exterior care, fiind în mod normal mai rece decât pereții interiori, poate presupune măsurarea unei temperaturi mai mici decât temperatura reală a camerei;
- condiții instabile: orice evaluare trebuie făcută în condiții stabile de lucru. În acest scop, temperatura de confort ar trebui modificată la numai 120 de minute după o schimbare anterioară. Nu este posibil, într-adevăr, să se evalueze corect temperatura camerei menținută de produs dacă temperatura nivelului de confort este modificată continuu într-un timp scurt.



Dacă se detectează o diferență între temperatura setată și temperatura camerei în condiții stabile de lucru, este posibil să se regleze măsurarea efectuată de termostatul electronic al produsului. Această operațiune este, de asemenea, deosebit de utilă atunci când instalați încălzitorul foarte aproape de podea sau tavan.

Pentru a seta această corecție, procedați după cum urmează:



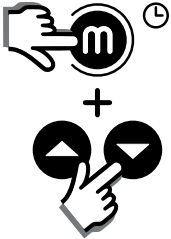
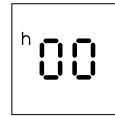

Țineți apăsată tasta  afișajul va afișa ora curentă.

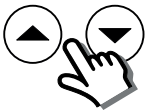
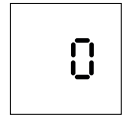
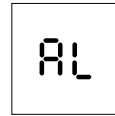

În timp ce țineți apăsată tasta  apăsați tastele  și  în același timp. Afișajul arată „AL” (alinieră) timp de 2 secunde și apoi valoarea reală a alinierii (valoarea implicită este 0).



Folosiți tastele  și  pentru a seta alinierea dorită, alegând o valoare între -5 și +5. Exemplu de aliniere: Dacă produsul a fost setat la 19°C, dar în încăperea se măsoară 20°C în condiții stabile, alinierea care trebuie introdusă este egală cu $20-19 = 1$; Dacă, pe de altă parte, produsul este setat la 19°C, dar în încăperea se măsoară 17°C, alinierea care trebuie setată este egală cu $17-19 = -2$.

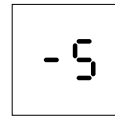

...

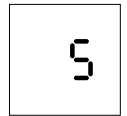

Apăsați butonul  pentru a ieși din aliniere și a relua funcționarea normală.



PROGRAM SĂPTĂMÂNAL

Modul Programat permite setarea, pentru fiecare oră din zi și pentru fiecare zi a săptămânii în mod independent, a temperaturii dorite alegând între Confort, Eco (egal cu cel al Confortului scăzut cu 3,5°C) sau Fără îngheț.



Pentru a activa modul Programat, apăsați tasta  până când afișajul arată „Pr”. Dacă produsul este nou, programul implicit este următorul:

întotdeauna modul fără îngheț, cu excepția modului Confort, în următoarele ore:

- de la 06:00 la 08:00 luni-vineri;
- de la 08:00 la 10:00 sâmbătă-duminică.

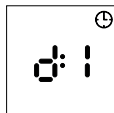
Când vă aflați în modul Programat, puteți afișa/modifica programul apăsând simultan tastele  și . Afișajul arată ziua 1 (luni).



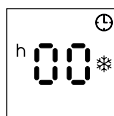

Prin apăsarea tastelor  și  sunt afișate diferitele ore ale zilei începând de la „00” (ora între 00:00 și 00:59). Temperatura de referință setată pentru timpul selectat este indicată prin pornirea pictogramei anti-îngheț (temperatura de 7°C), a pictogramei Eco (temperatura Eco = Confort - 3,5°C) sau a celei Confort (temperatura de confort setată de utilizator).

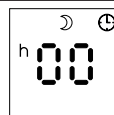
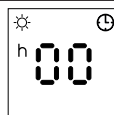
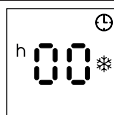

Temperatura dorită poate fi modificată apăsând tasta . Iluminarea în secvența pictogramelor descrise mai sus indică temperatura de referință.



Apasă  și  pentru a vedea/modifica temperatura pentru fiecare dintre orele din ziua 1, de la 00 la 23.

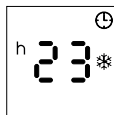

La ora 11 (23), apăsarea din nou a tastei  permite accesul la programarea pentru ziua 2.

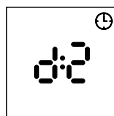

Acum este posibil să alegeți dacă să afișați/modificați temperatura orilor individuale din ziua 2 sau să setați ziua 2 identică cu ziua

1. În primul caz, utilizați  și  așa cum este deja descris

pentru ziua 1, în a doua apăsați din nou butonul . Procedând astfel, ziua 2 este setată automat la egală cu ziua 1 și sistemul trece la începutul zilei 3. Această procedură poate fi repetată până la programarea pentru ziua 7.

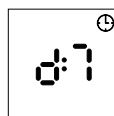
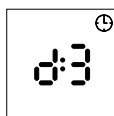

La finalul programării în ziua 7, sau în orice fază intermediară

a programării, după apăsarea tastei , accesați faza de salvare a programului. Pe display apare mesajul „OK” și programul tocmai definit este stocat.

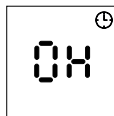





Notă:



- în orice moment este posibil să renunți la procedura de vizualizare/modificare prin ștergerea modificărilor încă nesalvate, așteptând 30 de secunde fără a atinge nicio tastă;
- în timpul programării elementele de încălzire sunt deconectate și produsul nu se încălzește.

FUNCTIA BOOST

Funcția Boost vă permite să activați funcționarea temporizată la putere maximă fără a controla termostatul. La sfârșitul acestei operațiuni forțate, radiatorul revine la modul de funcționare înainte de activare.

Pentru a activa funcția apăsați și în același timp butoanele  și . Durata implicită de 60 de minute clipește pe afișaj. Durata poate fi aleasă între valorile de 60, 90 sau 120 de minute (2h) folosind săgețile  și . La 5 secunde după ultima selecție, funcția este activată. Dacă timpul rămas este mai mic sau egal cu 59 min, afișajul arată minutele rămase de încălzire. Dacă este mai mare, arată minutele rămase precedate de afișarea cuvântului „1h” timp de 3 secunde.

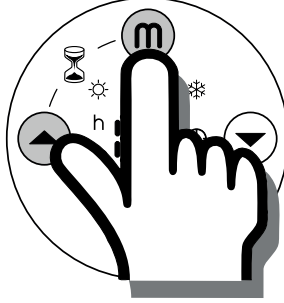

7. DEPANAREA

- În cazul supraîncălzirii, dispozitivul de protecție din interiorul produsului dezactivează atât rezistența. În acest caz:
 - Opriți convectorul și lăsați-l să se răcească timp de aproximativ 15/20 minute;
 - Eliminați orice posibilă cauză de supraîncălzire (de exemplu: obstrucția la grilele de ieșire aer, reziduuri de murdărie pe produs etc.);
 - Porniți din nou convectorul și verificați dacă acesta funcționează corect.
- Dacă comenzile de control tactil sunt blocate sau nu răspund corect la presiunea digitală, opriți încălzitorul folosind comutatorul electromecanic din partea stângă a încălzitorului. Apoi porniți încălzitorul folosind același întrerupător.

8. ÎNTREȚINERE

- Acest produs nu necesită nicio întreținere specială.
- Curățați produsul cu o cârpă uscată o dată la 6 luni.
- Dacă produsul necesită reparații, contactați un centru de service tehnic autorizat.
- Când înlocuiți cablul de alimentare, utilizați un tip H05V2V2-F HAR de 2x1,00 mm². Această operațiune trebuie efectuată de personal calificat și niciodată de utilizatorul final pentru a evita deteriorarea aparatului și periclitarea siguranței personale.

9. PREVEDERI LEGALE



Protecția mediului și reciclarea

Pentru ca aparatul să nu fie deteriorat în timpul transportului, a fost ambalat cu grijă. Pentru a contribui la protecția mediului nostru, vă rugăm să eliminați corespunzător materialul utilizat pentru ambalarea corectă a aparatului.

Eliminarea aparatelor uzate

Aparatele marcate cu marcajul lateral nu trebuie aruncate împreună cu deșeurile menajere, ci trebuie colectate și eliminate separat. Eliminarea echipamentelor uzate trebuie efectuată într-o manieră adecvată, în conformitate cu regulamentele și reglementările aplicabile la nivel local.

Informații obligatorii pentru încălzitoarele electrice locale

Identificator model: ONSEN					
Data	Simbol	Valoare	Unitati	Date	Unitati
Putere termica				Tipul de căldură, numai pentru încălzitoare electrice locale de stocare (indicați numai o singură opțiune)	
Putere termica nominala	P_{nom}	0,750	kW	controlul manual al sarcinii termice, cu termostat integrat	nu
Putere termica minima (indicativa)	P_{min}	0,750	kW	controlul manual al sarcinii termice cu feedback ambiental la temperatura camerei și / sau exterior	nu
Putere maxima termica continua	$P_{max,c}$	0,750	kW	control electronic al sarcinii termice cu feedback ambiental la temperatura camerei și / sau exterior	nu
Consum auxiliar de energie electrica				ventilator asistat de putere termică	nu
La putere termica nominala	$e_{l,max}$	0,000	kW	Tipul de ieșire termică / controlul temperaturii camerei (indicați doar o opțiune)	
La putere termica minima	$e_{l,min}$	0,000	kW	puterea termică monofazată fără controlul temperaturii ambientale	nu
In mod standby	$e_{l,SB}$	0,343	W	două sau mai multe faze manuale fără a controla temperatura camerei	nu
				cu reglarea temperaturii camerei prin intermediul termostatului mecanic	nu
				cu control electronic al temperaturii ambiante	nu
				cu control electronic al temperaturii camerei și al cronometrului zilnic	nu
				cu control electronic al temperaturii camerei și al cronometrului săptămânal	si
				Mai multe opțiuni de control (puteți selecta mai multe opțiuni)	
				controlul temperaturii camerei cu detectarea prezenței	nu
				controlul temperaturii camerei cu detectarea ferestrelor deschise	si
				cu opțiunea de control la distanță	nu
				cu control adaptiv de pornire	nu
				cu limitarea timpului de funcționare	nu
				cu termometru cu glob negru	nu
Contactati-ne	Distribuitorul sau Ermete Giudici S.p.A. - via L. da Vinci, 27 - 20090 Segrate (MI) Italy				

Valori de referință ca la 230V 50Hz

Avant d'utiliser le radiateur, lire attentivement les instructions afin d'éviter tout danger ou d'utilisation inappropriée de l'appareil. Toutes utilisations autres que celles décrites dans cette notice seront considérées comme dangereuses et risquent de causer des incendies, des chocs électriques ou des blessures et ne seront pas couverts par la garantie.

La garantie ne s'applique pas en cas de défaut, détérioration, dommages causés en raison d'un usage impropre ou d'un abus dans l'utilisation du radiateur. Vous pouvez disposer de droits reconnus par la loi de votre pays. Aucune disposition de la présente garantie ne peut avoir pour effet d'exclure quelque garantie ou droit reconnu d'ordre public par la législation de votre pays.

Avant toute opération, ôter l'emballage du produit et vérifier si l'appareil n'est pas endommagé. En cas de défaut, de choc ou de dommage, ne pas essayer de réparer l'appareil vous-même et contacter votre revendeur.

Ne pas laisser les enfants jouer avec les emballages et protéger l'environnement en jetant les cartons et les calages dans les endroits appropriés pour le recyclage.

1. POUR VOTRE SÉCURITÉ

- Cet appareil est destiné à un usage strictement domestique. Il ne doit pas être utilisé dans des véhicules (automobile, bateau, avion).
- Cet appareil peut être utilisé par des enfants âgés de 8 ans et plus et les personnes manquant d'expérience et de connaissances ou dont les capacités physiques, sensorielles ou mentales sont réduites, si elles ont été formées et encadrées quant à l'utilisation de l'appareil d'une manière sûre et connaissent les risques encourus. Les enfants ne doivent pas jouer avec l'appareil. Le nettoyage et l'entretien par l'utilisateur ne doit pas être fait par des enfants à moins qu'ils soient âgés de 8 ans et plus et supervisés
- Les enfants de moins de 3 ans doivent être tenus à l'écart à moins d'être surveillés en continu.
- Les enfants âgés entre 3 ans et 8 ans ne peuvent allumer ou éteindre l'appareil qu'à condition qu'il ait été placé ou installé dans sa position normale de fonctionnement et qu'ils aient reçu l'autorisation ainsi que toutes les instructions concernant l'utilisation de l'appareil d'une manière sûre et les risques encourus. Les enfants âgés entre 3 et 8 ans ne peuvent pas brancher, régler, nettoyer l'appareil ou effectuer la maintenance utilisateur.
- **ATTENTION - Certaines parties de ce produit peuvent devenir très chaudes et provoquer des brûlures. Il faut prêter une attention particulière en présence d'enfants et de personnes vulnérables.**
- Vérifier si la tension du secteur est la même que celle de l'appareil. 230-240V AC, 50Hz.

- Attention: Ne pas utiliser cet appareil de chauffage dans l'environnement immédiat d'une baignoire, d'une douche ou d'une piscine. Il ne doit pas être possible d'accéder aux commandes de l'appareil à partir de la baignoire ou de la douche ou lorsque l'on est en contact avec de l'eau (Utilisation en volume 0, ou 1 figure 2 d'une salle de bain strictement interdit). L'appareil a un degré d'imperméabilité IPX4.
- Pendant le fonctionnement, placer l'appareil dans un endroit sûr de manière à:
 - que l'appareil soit au moins à 1 m des objets inflammables ou des meubles;
 - Laisser libre la grille de sortie d'air: pour qu'aucun objet ne doit être à moins d'un 1 m de la grille de sortie d'air;
 - Ne jamais installer immédiatement l'appareil en-dessous d'une prise de courant.
- Ne laisser jamais les enfants ou les animaux domestiques toucher ou jouer avec l'appareil. Attention ! Lorsque l'appareil est en fonction, le panneau est parfois très chaud (>90°C)
- Ne pas utiliser cet appareil dans des atmosphères saturées en gaz explosifs, en vapeurs produits par des solvants ou des peintures, ni en vapeurs/gaz inflammables.
- Si le câble d'alimentation est endommagé, il doit être changé par le fabricant, son service de maintenance ou une personne de qualification similaire afin d'éviter un danger.
- L'appareil doit être installé de manière à ce que la prise soit toujours accessible.
- Ne jamais installer l'appareil sur des surfaces en bois ou en matériaux synthétiques.
- **AVERTISSEMENT:** ne pas utiliser le radiateur dans de petites pièces en présence de personnes qui ne sont pas en mesure de les quitter par elles-mêmes, à moins qu'elles ne soient sous la surveillance d'une personne responsable de leur sécurité;
- **AVERTISSEMENT:** pour réduire le risque d'incendie, maintenir les tissus, les rideaux ou tout autre matériau inflammable à une distance d'au moins 1 m de la grille de sortie d'air.
- **AVERTISSEMENT:** Ce produit doit être utilisé que pour sécher des serviettes mouillées avec de l'eau.

2. VOTRE APPAREIL

- Dans le carton de l'appareil, vous devez trouver (figure 1):
 - N°1 fixation métalliques pour la fixation au mur (fixé sur le radiateur);
 - N°4 cheville à expansion en nylon 8x50mm;
 - N°4 vis 5x60mm;
 - N°2 barres porte-serviettes;
 - N°4 vis 3,9x13mm pour le montage des barres porte-serviettes.
- Contactez votre revendeur s'il vous manque des pièces.

3. INSTALLATION ET FIXATION AU MUR

- Installer uniquement l'appareil en position verticale.
- L'appareil dispose d'une double isolation électrique (classe II) et ne nécessite donc d'aucune mise à la terre.
- Ce radiateur doit être installé en respectant les Normes d'installation en vigueur dans votre Pays.
- Dans les environnements humides tels que les salles de bains et les cuisines, le raccordement au réseau électrique doit être à au moins 25 cm de sol. Les dispositifs de déconnexion du secteur doivent permettre une déconnexion complète dans conditions de la catégorie de surtension III.
- Si vous avez l'intention de monter l'une ou les deux barres porte-serviettes sur le produit, vous devez le faire avant d'installer le produit au mur. Pour le montage, utiliser les vis illustrées dans la figure 3.
- Pour installer le produit, respectez toujours les distances minimales des parois latérales, du sol, du plafond, des meubles et d'autres objets, comme précisé dans la figure 4. N'installez jamais le produit à une hauteur au-dessus du sol inférieure à 30 cm. Pour le montage mural :
 - retirez le support de fixation du produit en décrochant les deux ressorts situés dans la partie basse du support
 - avec un crayon, marquez sur le mur les points pour l'insertion des chevilles et des vis de fixation (figure 5)
 - percez le mur au niveau des 4 points que vous avez marqués ; insérez les 4 chevilles à expansion
 - fixez le support mural avec les 4 vis fournies (figure 6)
 - accrochez le radiateur à la partie haute du support mural puis relâchez les deux ressorts situés dans la partie basse du support (figure 7).
 - Au cas où vous devriez enlever le radiateur du mur, nous conseillons de décrocher d'abord les deux ressorts dans la partie basse du support, puis de soulever le produit vers le haut en le libérant des crochets supérieurs.

4. SERVIETTES

- Répartissez toujours les serviettes de manière uniforme sur la surface des barres (figure 8-A);
- Ne posez jamais des serviettes ou des vêtements sur le dessus du radiateur (figure 8-B);
- Ne superposez jamais les serviettes sur plusieurs couches ; surtout, ne coincez jamais les serviettes entre la barre et la face avant du radiateur (figure 8-C).

5. DESCRIPTION DES COMMANDES ET DU FONCTIONNEMENT

- Les commandes suivantes sont intégrées à l'avant du produit (figure 9):
 - A - Veille
 - B - Augmentation
 - C - Diminution
 - D - Mode
 - E - Écran

Le radiateur peut fonctionner selon 3 modes différents : Automatique, Programmé ou Antigel:

Mode Automatique

Dans ce mode, le produit fonctionne pour atteindre et maintenir la température Confort réglée par l'utilisateur. Un système de gestion automatique de la puissance permet un contrôle optimal des consommations et une régulation précise du niveau de confort en maintenant automatiquement la température sélectionnée constante dans le temps, conformément à ce qui a été réglé sur le thermostat électronique.

En mode Automatique, il existe par ailleurs une fonction spéciale, que l'utilisateur peut activer s'il le souhaite, qui permet de détecter l'ouverture d'une fenêtre et de forcer le fonctionnement en mode antigel pour limiter au maximum le gaspillage d'énergie.

Mode Programmé

Le produit peut être programmé sur une base horaire pour chaque jour de la semaine. Pour chaque heure de chaque jour, en effet, il est possible de définir la température de référence à atteindre/maintenir en choisissant parmi les températures Confort, Eco (dont la valeur est égale à la température Confort réduite de 3,5°C) ou Antigel.



Pendant toute la durée de fonctionnement en mode Programmé, la détection de l'ouverture de fenêtre est désactivée afin que le produit puisse suivre correctement le profil de température défini par l'utilisateur.

Mode Antigel

Dans ce mode, le thermostat est automatiquement réglé pour maintenir une température de $7\pm 3^{\circ}\text{C}$.

6. UTILISATION DU RADIATEUR

BOUTON DE MISE EN VEILLE

Utilisez le bouton  pour allumer le produit ou le mettre en veille. Lorsque le produit est en veille, deux tirets blancs apparaissent sur l'écran:

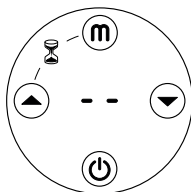

À l'allumage, le produit passe en mode automatique. Le message « AU » apparaît pendant 3 secondes sur l'écran, puis la température réglée est affichée:

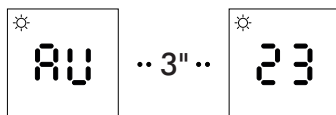

MODE DE FONCTIONNEMENT

Utiliser le bouton  pour changer de mode de fonctionnement et basculer entre Automatique, Programmé et Antigel comme décrit dans la section 5.



Appuyer sur le bouton  pour passer du mode automatique au mode Programmé. L'écran affiche le message « Pr ».

L'écran affiche également le symbole de l'horloge et l'icône correspondant au mode de fonctionnement prévu pour l'heure et le jour en cours (Confort, Eco ou Antigel).

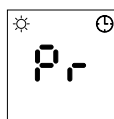



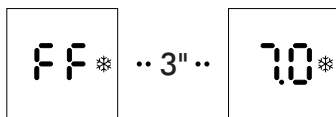

Appuyer sur le bouton  pour passer du mode Programmé au mode Antigél. L'écran affiche le message « FF » pendant 3 secondes, puis la température prévue de 7°C (non modifiable). Le symbole du mode Antigél s'allume également sur l'écran.



Appuyer à nouveau sur le bouton  pour revenir au mode automatique et recommencer le cycle.

RÉGLAGES

Les boutons ,  et , permettent de régler l'heure et le jour, la température Confort et d'activer ou de désactiver la détection de l'ouverture des fenêtres. Le jour « 1 » correspond au LUNDI.



Appuyer sur le bouton  pendant au moins 3 secondes pour afficher/modifier les réglages en commençant par l'heure.

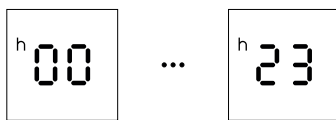

Utiliser les boutons  et  pour régler l'heure.



Appuyez sur le bouton  pour passer au réglage des minutes.

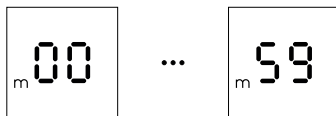

Utiliser les boutons  et  pour régler des minutes.



Appuyez sur le bouton  pour passer au réglage du jour.

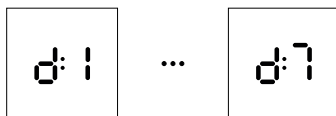

Utiliser les boutons  et  pour définir le jour (1 = lundi).



Appuyer sur le bouton  pour passer au réglage de la détection de l'ouverture des fenêtres.

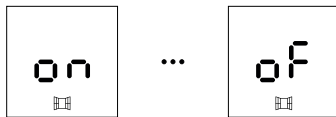

Utiliser les boutons  et  pour activer ou désactiver la détection de l'ouverture des fenêtres.



Appuyer sur le bouton  pour terminer le réglage et revenir au fonctionnement normal.

CAPTEUR DE FENÊTRE OUVERTE

Cette fonction permet de détecter l'ouverture d'une fenêtre et de régler automatiquement le mode de fonctionnement Antigél. L'allumage de l'icône correspondante dans la partie inférieure de l'écran indique que la fonction est disponible et prête à activer le mode Antigél si l'ouverture d'une fenêtre est détectée.

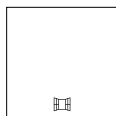

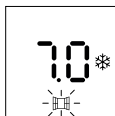

Si une chute brutale de la température est détectée pendant le fonctionnement normal du produit, le mode Antigél est automatiquement activé pour réduire le gaspillage d'énergie. L'écran affiche le mode Antigél et l'icône de la fenêtre clignotante.



Le retour au fonctionnement normal n'est pas automatique mais s'effectue en appuyant sur l'un des boutons du produit.

 Le bon fonctionnement de cette fonction peut dépendre du positionnement du produit dans la pièce, de la présence de courants d'air, de la température extérieure et du temps d'ouverture de la fenêtre.

AFFICHER / MODIFIER LA TEMPÉRATURE CONFORT

La température Confort pré réglée est affichée en mode automatique et peut être modifiée en appuyant sur les boutons  et . La température Eco, utilisée dans la programmation, n'est pas modifiable et est toujours égale à la température Confort -3,5°C. La température Antigel est également fixe et égale à 7°C.

REMARQUE : La température mesurée par le capteur à l'intérieur du produit indique toujours la température ambiante à proximité immédiate du produit et peut différer de la température mesurée avec d'autres instruments dans d'autres zones de la pièce. Cette différence peut dépendre de divers facteurs, tels que :

- L'emplacement de l'installation : certaines zones de la pièce peuvent être affectées par des courants d'air ou des poches d'air chaud qui peuvent modifier la mesure du capteur ;
- L'installation sur un mur périmétrique extérieur, qui est normalement plus froid que les murs intérieurs, peut entraîner une mesure de température inférieure à la température réelle de la pièce ;
- Conditions instables : toute évaluation doit être effectuée dans des conditions de fonctionnement stables. Pour cette raison, la température Confort ne doit pas être modifiée avant que 120 minutes ne se soient écoulées depuis la précédente modification. En effet, il n'est pas possible d'évaluer si la température ambiante est correctement maintenue par le produit si le niveau de température est continuellement modifié sur une courte période de temps.



S'il existe une différence entre la température programmée et la température ambiante mesurée par d'autres instruments dans des conditions stables, il est possible de corriger la mesure effectuée par le thermostat électronique du produit. Cette opération est particulièrement utile y compris lorsque le radiateur est installé très près du sol ou du plafond.

Pour régler cette correction, procéder comme suit:

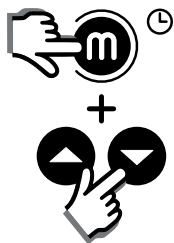
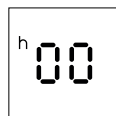

Appuyer et MAINTENIR ENFONCÉ le bouton  : l'écran affiche l'heure courante.



Toujours en maintenant le bouton  enfoncé, appuyer aussi simultanément sur les boutons  et . L'écran affiche le message « AL » (alignement) pendant 2 secondes, suivi de la valeur de l'alignement saisie (la valeur par défaut est 0).

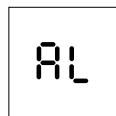

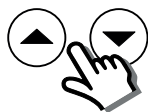

Utiliser les boutons  et  pour définir l'alignement souhaité en choisissant une valeur entre -5 et +5.

Exemple d'alignement:

Si le produit a été réglé sur 19°C mais que la température relevée dans la pièce est, dans des conditions stables, de 20°C, l'alignement à introduire est $20-19 = 1$;

Si, au contraire, le produit est réglé sur 19°C mais que dans la pièce on mesure, par exemple, 17°C, l'alignement à introduire est $17-19 = -2$.



Appuyer sur le bouton  pour terminer l'alignement et revenir au fonctionnement normal.

PROGRAMMATION HEBDOMADAIRE

Le mode Programmé permet de régler indépendamment la température souhaitée pour chaque heure de la journée et pour tous les jours de la semaine, en choisissant entre Confort, Eco (égal à Confort réduit de 3,5°C) ou Antigel. Il est activé en utilisant le bouton  jusqu'à ce que le message « Pr » apparaisse sur l'écran. Si le produit est neuf, le profil par défaut du programme est le suivant :

Toujours Antigel avec activation du mode Confort :

- De 06:00 à 08:00 du lundi au vendredi ;

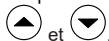

- De 08:00 à 10:00 les samedis et dimanches.

En mode programmation, l'affichage/le changement de programme peut être activé en appuyant simultanément sur les boutons



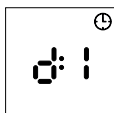

L'écran affiche le jour 1 (lundi).

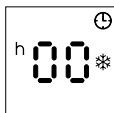

En appuyant sur les boutons  et  les différentes heures de la journée sont affichées en commençant par « 00 » (heure comprise entre 00:00 et 00:59).

La température de référence réglée pour le temps sélectionné est indiquée par l'allumage de l'icône Antigel (température de 7°C), de l'icône Eco (température Eco = Confort - 3,5°C) ou de l'icône Confort (température Confort réglée par l'utilisateur).



La température souhaitée peut être modifiée en appuyant sur le bouton . L'allumage séquentiel des icônes ci-dessus indique la température de référence.

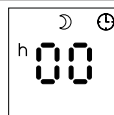
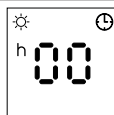
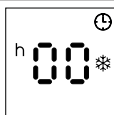

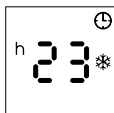

Utiliser les boutons  et  pour afficher/modifier la température réglée pour chacune des heures du jour 1, de 00 à 23.

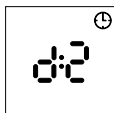

Arrivé à 23 heures, une nouvelle pression sur le bouton  permet d'accéder à la programmation du jour 2.



A ce stade, il est possible de choisir d'afficher/modifier la température des différentes heures du jour 2 ou de régler le jour 2 de la même manière que le jour 1. Dans le premier cas, utiliser

les boutons  et  comme déjà illustré pour le jour 1, dans le second cas, il suffit d'appuyer une nouvelle fois sur le bouton

. Ce faisant, le jour 2 est automatiquement égal au jour 1 et le système passe au début du jour 3. Cette procédure peut être répétée jusqu'à la programmation du jour 7.

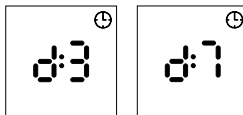

À la fin de la programmation du jour 7, ou à toute étape intermédiaire de la programmation, une pression sur le bouton

 permet de passer à la phase de sauvegarde du programme. Le message « OK » apparaît à l'écran et le programme nouvellement défini est enregistré.



Veillez noter:





-À tout moment, il est possible de quitter la procédure d'affichage/de modification en effaçant les modifications non encore sauvegardées en attendant 30 secondes sans toucher aucun bouton;

-Durant la programmation, les éléments chauffants sont désactivés et le radiateur ne chauffe pas.

FUNCTION BOOST

La fonction BOOST permet un fonctionnement temporisé du radiateur pour la durée souhaitée, et sans le contrôle de la température ambiante. Lorsque le temps sélectionné s'est écoulé, le radiateur se remet à fonctionner dans la modalité établie avant l'activation de la temporisation.

Pour activer la temporisation, appuyez simultanément sur les touches  et . Le temps défini pour la temporisation est de 60 min. ; ce chiffre clignote sur l'afficheur pendant quelques secondes. Durant cette phase il est possible de modifier la durée entre 60, 90 et 120 min. (2h), au moyen des touches * et *. Après 5 s, la durée affichée à l'écran cesse de clignoter et la temporisation est définie. A partir de ce moment l'afficheur montre la durée restante de la temporisation.

Si la durée restante est comprise entre 1 heure et 2 heures, les minutes restantes (de 1 à 59) s'afficheront pendant 3 s, suivies de l'indication « 1h ». Si la durée restante est inférieure à 1 heure, seules les minutes restantes (de 1 à 59) seront affichées.

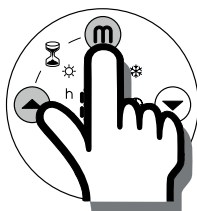

7. EN CAS DE FONCTIONNEMENT ANORMAL

- En cas de surchauffe le système de protection de l'appareil désactive automatiquement les éléments chauffants et le moteur, en faisant interrompre ainsi le fonctionnement du radiateur. Dans ce cas :
 - Eteindre le radiateur et le laisser refroidir pour environ 15/20 minutes
 - Enlever d'éventuelles autres causes de surchauffe (par ex. obstacles devant la grille d'entrée et/ou sortie de l'air, accumulation anormale de saleté etc.).
 - Allumer à nouveau le radiateur et vérifier le fonctionnement correct.
- Si les commandes tactiles sont bloquées ou ne répondent pas correctement à une pression digitale, éteignez l'appareil à l'aide de l'interrupteur situé sur le côté gauche de l'appareil. Redémarrez ensuite l'appareil avec le même interrupteur.

8. ENTRETIEN

- Cet appareil n'a besoin d'aucun entretien particulier.
- Nous vous recommandons de nettoyer l'appareil tous les 6 mois, à l'aide d'un chiffon sec.
- Si l'appareil doit être réparé, s'adresser à un service après-vente.
- Si vous devez remplacer le câble d'alimentation ne pas oublier que vous devez obligatoirement utiliser un câble de, 2x1,00 mm² H05V2V2-F <HAR>. Qu'il s'agisse des câbles munis ou dépourvus de fiche. Si le câble d'alimentation est endommagé, il doit être changé par le fabricant, son service de maintenance ou une personne de qualification similaire afin d'éviter un danger.

9. AVERTISSEMENT LEGAL



Environnement et recyclage

Nous vous demandons de nous aider à préserver l'environnement. Pour ce faire, merci de vous débarrasser de l'emballage conformément aux règles nationales relatives au traitement des déchets.

Collecte et recyclage des produits en fin de vie

Les appareils munis de ce symbole ne doivent pas être mis avec les ordures ménagères, mais doivent être collectés séparément et recyclés. La collecte et le recyclage des produits en fin de vie doivent être effectués selon les dispositions et les décrets locaux.

Exigences d'informations applicables aux dispositifs de chauffage décentralisés électriques

Référence(s) du modèle: ONSEN					
Caractéristique	Symbole	Valeur	Unité	Caractéristique	Unité
Puissance thermique				Type d'apport de chaleur, pour les dispositifs de chauffage décentralisés électriques à accumulation uniquement (sélectionner un seul type)	
Puissance thermique nominale	P_{nom}	0,750	kW	contrôle thermique manuel de la charge avec thermostat intégré	non
Puissance thermique minimale (indicative)	P_{min}	0,750	kW	contrôle thermique manuel de la charge avec réception d'informations sur la température de la pièce et/ou extérieure	non
Puissance thermique maximale continue	$P_{max,c}$	0,750	kW	contrôle thermique électronique de la charge avec réception d'informations sur la température de la pièce et/ou extérieure	non
Consommation d'électricité auxiliaire				puissance thermique réglable par ventilateur	non
À la puissance thermique nominale	$e_{l,max}$	0,000	kW	Type de contrôle de la puissance thermique/de la température de la pièce (sélectionner un seul type)	
À la puissance thermique minimale	$e_{l,min}$	0,000	kW	contrôle de la puissance thermique à un palier, pas de contrôle de la température de la pièce	non
En mode veille	$e_{l,SB}$	0,343	W	contrôle à deux ou plusieurs paliers manuels, pas de contrôle de la température de la pièce	non
				contrôle de la température de la pièce avec thermostat mécanique	non
				contrôle électronique de la température de la pièce	non
				contrôle électronique de la température de la pièce et programmeur journalier	non
				contrôle électronique de la température de la pièce et programmeur hebdomadaire	oui
				Autres options de contrôle (sélectionner une ou plusieurs options)	
				contrôle de la température de la pièce, avec détecteur de présence	non
				contrôle de la température de la pièce, avec détecteur de fenêtre ouverte	oui
				option contrôle à distance	non
				contrôle adaptatif de l'activation	non
				limitation de la durée d'activation	non
				capteur à globe noir	non
Coordonnées de contact	E. Giudici S.p.A. - via L. da Vinci, 27 - 20090 Segrate (MI) - Italy				

Valeur de référence en 230V 50Hz